

Flexible feeding system aflex 400 lv



Operating or assembly instructions

Copyright by Afag GmbH



This operating manual is valid for:

Type		Order number
aflex 400 lv	Basis with white back light	50540944
	White POM FDA plate for transported material	50540946

Type		Order number
aflex Control	Standard Digital I/O	50473414
	Profibus extension	50441875
	EtherCAT extension	50473416
	Profinet extension	50473418
	EtherNet/IP extension	50473417

Version of this documentation BA_aflex 400 lv_R01.41_EN.docx
Release: R01.41
Date: 29.03.2022

History

version	changes
R01.00	Operating instructions for aflex 400 lv created EtherNet/IP interface added
R01.20	Order address Afag Switzerland updated Technical data updated
R01.30	Minor corrections
R01.40	Minor corrections
R01.41	Technical data updated

Content:

1	Safety instructions	6
1.1	Explanation of symbols and instructions.....	6
1.2	Basic safety instructions.....	6
1.2.1	Electrical Connection	7
1.2.2	Danger zones	8
1.3	Intended use	8
1.4	Obligations of the operator.....	9
2	Description of the device.....	12
2.1	General.....	12
2.2	Technical data.....	13
2.2.1	Maximum size of the parts.....	18
2.2.2	Maximum part weight.....	18
2.3	Electrical/Control Components.....	19
3	Installation instructions	20
3.1	Transport.....	20
3.2	Assembly of the device	21
3.2.1	Drilling picture for assembly.....	21
3.2.2	Dimensions of the base plate.....	21
3.2.3	Assembly on base plate.....	22
3.2.4	Dismantling the funnel plate	22
3.2.5	Tighten Flex sockets.....	23
3.2.6	Remove transport safety.....	23
3.2.7	Install funnel plate.....	23
3.3	Connection of the device.....	24
3.4	Power supply.....	24
3.5	Connection of the control	25
3.5.1	Building the control module	25
3.5.2	Electrical Connection aflex 400 Iv.....	27
4	Software description	29
4.1	Installation of the Software.....	29
4.2	User groups.....	30
4.3	Start page.....	31
4.3.1	ControlUnit states	33
4.3.2	Advanced display for Advanced user.....	35
4.3.2.1	Function "add ControlUnit".....	35
4.3.3	Extended display Administrator	36
4.3.4	Connection set-up.....	36
4.4	Main menu.....	37
4.5	Control interface	40
4.5.1	Aflex control panel aflex 400 Iv	40
4.5.1.1	"Soft-Release".....	42
4.5.1.2	Intensity limitation user level "Administrator"	44
4.5.2	Aflex configurations	45
4.5.3	Backlight	47

4.5.4	Simulation of the external control.....	48
4.5.4.1	Demo Configurator.....	49
4.6	Sub menu controller.....	51
4.7	Sub menu clients.....	57
4.7.1	Client Nodes Functions.....	60
4.7.2	T4X Client Node.....	62
4.7.3	Backlight Node.....	65
4.7.4	Profibus Module.....	67
4.7.5	EtherCAT Module.....	69
4.7.6	Profinet Modul.....	71
4.7.7	EtherNet/IP Modul.....	74
4.7.8	Webserver Profinet & EtherNet/IP.....	78
4.8	Sub menu Fieldbus configuration.....	80
4.8.1	“Direction” command for aflex lv products.....	83
4.9	Sub menu aflex module.....	85
4.9.1	Test electrical Connection.....	89
4.10	Software update.....	90
4.10.1	The Bootloader.....	90
4.10.2	Software update ControlUnit.....	90
4.10.3	Software update Client Node.....	93
5	First commissioning.....	95
5.1	Assembly of the system.....	95
5.2	Connect to control unit.....	95
5.3	Configure ControlUnit.....	95
5.4	Configure client nodes.....	95
5.5	Configure software modules.....	96
5.6	Integration with higher control.....	96
5.6.1	Development of transfer values.....	99
5.6.2	Digital input/output.....	100
5.6.2.1	Strategy 1.....	102
5.6.2.2	Strategy 2.....	104
5.6.2.3	Strategy 3.....	106
5.6.3	Telnet-Server.....	108
5.6.4	Profibus module.....	111
5.6.5	EtherCAT Module.....	114
5.6.6	Profinet Modul.....	116
5.6.7	EtherNet/IP Modul.....	118
5.6.8	Input commands.....	120
5.6.9	Output commands.....	123
6	Operating manual.....	125
6.1	Safety instructions for operation.....	125
6.2	LED Display.....	125
7	Maintenance instructions.....	128
8	Order address.....	129
9	Disposal.....	129

1 Safety instructions

1.1 Explanation of symbols and instructions

Symbols: Installation and commissioning shall be done only by qualified personnel according to operating manual.

Please observe the importance of following explanation symbols and instructions. They are divided and classified in danger levels according to ISO 3864-2.

 DANGER	
	<p>Indicates a direct potential danger.</p> <p>When the information is not followed, it can lead to death or severe body injuries (disability).</p>

 WARNING	
	<p>Indicates a possible threatening situation.</p> <p>When the information is not followed, it can lead to death or severe body injuries (disability).</p>

 CAUTION	
	<p>Indicates a possible dangerous situation.</p> <p>When the information is not followed, it can lead to property damage and mild or indirect body injuries.</p>

INSTRUCTION	
	<p>Indicated general instructions, useful application-tips and operation recommendations which however have no impact on the safety or health of personnel.</p>

1.2 Basic safety instructions

This operating manual serves as the base to start the flexible feeding device aflex and to operate it. This operating manual, in particular the safety instructions must be ob-

served which work on or with aflex. Furthermore, the respective valid rules and regulations for accident prevention must be observed for the operation site. The operating instructions must always be kept at the operation site of the aflex.

The device may only be operated by technically qualified personnel. Qualified personnel are persons that are responsible and authorized for the safety of the system due to their training, experience and teaching, as well as their knowledge of relevant norms, regulations, accident prevention rules and operating conditions, who carry out the respective required activities and thus identify possible dangers and can avoid them (Definition for specialists according to IEC 364).

Disturbances that impair the safety of personnel, of aflex or other material assets must be eliminated immediately.

The following instructions serve not only for the personal safety of the operating personnel, as well as the safety of the described products and the devices connected to them:

1.2.1 Electrical Connection

INSTRUCTION	
	<ul style="list-style-type: none"> ▪ Disconnect the voltage supply before assembly or dismantling, as well as structural changes. ▪ Observe valid accident prevention rules and safety regulations in specific application cases. ▪ Check if the working voltage of the device complies with the local working voltage before commissioning. ▪ EMERGENCY-STOP-Equipment must remain effective in all operating conditions. Unlocking the EMERGENCY-STOP-Equipment may not ensure uncontrolled restart. ▪ The electrical connections must be covered! ▪ Protective earth connections must be checked for proper functioning after assembly.

1.2.2 Danger zones

INSTRUCTION	
	<p>The flexible feeding devices from Afag are built according to EG machine guidelines, state of the art and the recognized technical safety regulations. Nevertheless during use, danger to life and limb of the operators or third parties or impairments to aflex or other material assets can arise.</p>

1.3 Intended use

The aflex serves for the excitation of conveyed goods, in particular piece goods through mechanical vibrations. With regard to the maximum permissible dimensions and weights of conveyed goods, the instructions in chapter 2.2

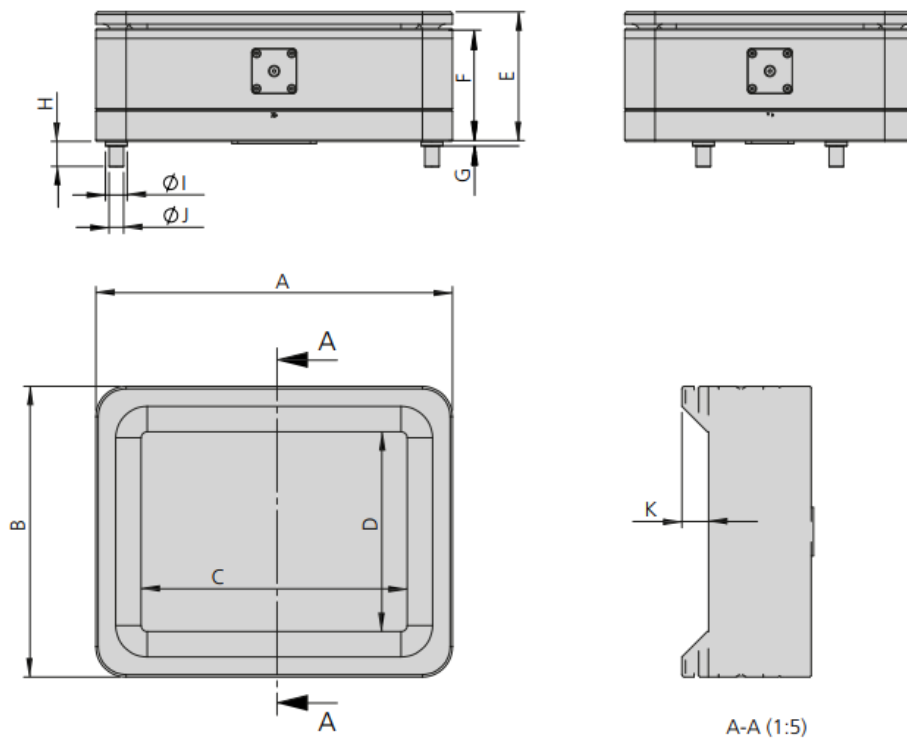

Table 1: **Technical data**

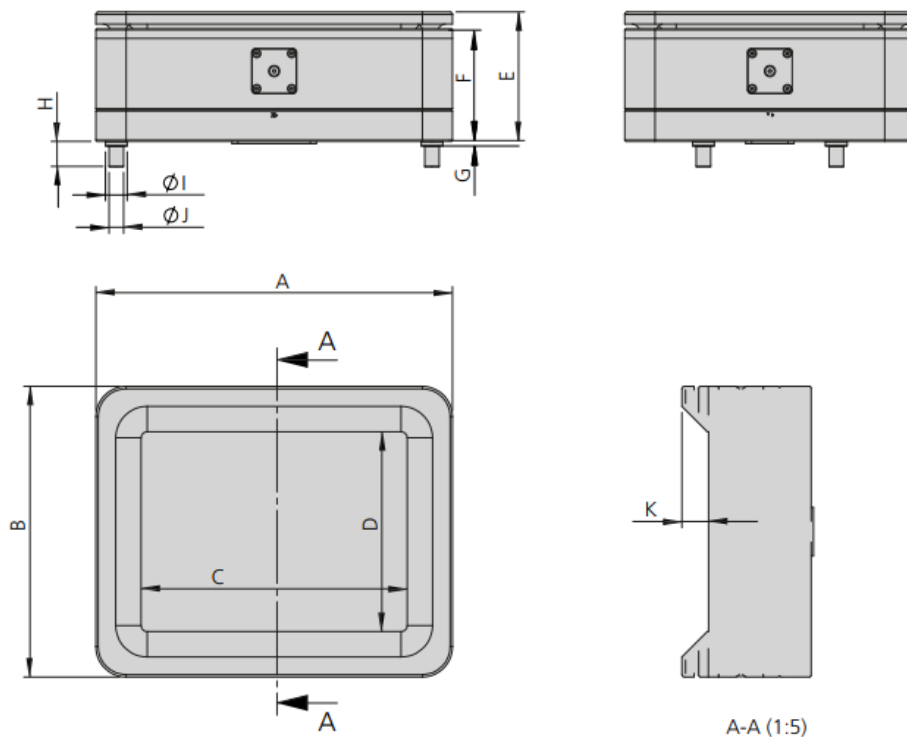



Table 1: **Technical** data must be observed. Proper use also includes observing all instructions in the operating manual, as well as observing all safety instructions.

 WARNING	
	<p>The aflex must <u>not</u> be used:</p> <ul style="list-style-type: none"> a) In humid and wet areas. b) At temperatures below 10°C or above 45°C c) In areas with easily flammable media d) In areas with explosive media e) In heavily polluted or dusty environments f) In an aggressive environment (e.g., saline atmosphere)

1.4 Obligations of the operator

A safety-related condition and use of the aflex is the prerequisite for safe operation. Therefore the operator is obligated to ensure that the following points are complied with:

Ensure that the aflex is operated by authorized personnel only.

Prohibit hazardous and dangerous work. Check the handling by the staff.

Have the personnel confirm with a signature that the operating instructions have been understood.

Ensure that a copy of the complete operating manual is permanently accessible at the aflex.

Check the operating manual regularly for a complete and legible condition.

Prescribe appropriate personal protective equipment (PPE) for activities with increased risk of injury.

Pinpoint the responsibilities according to the various tasks, installation, commissioning and operation.

You must immediately notify your supervisor personally of any occurring and recognizable malfunctions.

INSTRUCTION



All persons working at the aflex as well as persons who are employed under the Temporary Employment Act have a duty to cooperate for safety and health protection at the workplace. You must be instructed about using the aflex.

INSTRUCTION



Reasonably foreseeable misuse, the dangers for the user, third parties or for the aflex can bring along with it:

- a) The feeding of components whose size and geometry differs from the size and geometry provided for the aflex
- b) Operating the aflex outside the physical application limits described in chapter "Commissioning / Operation"
- c) Improper assembly, commissioning and operation of the aflex.
- d) Changing the control software without prior consultation with the manufacturer
- e) Operating the aflex at or with obvious faults and / or defects.
- f) Cleaning work without observing the safety precautions for aflex work on site.
- g) Improper assembly, commissioning and operation of the aflex.

INSTRUCTION



No modifications or alterations to the aflex or the aflex control may be carried out without the manufacturer's approval.

INSTRUCTION



Any further use or constructional alteration is deemed to be inappropriate and will lead to the termination of the warranty claim.

2 Description of the device

2.1 General

This manual describes the aflex 400 lv system. The aflex 150 & 200 systems are described in a separate operating manual.

The aflex system consists of an aflex and an external control. This is made up of individual control modules. In the standard configuration of the aflex 400 lv, one ControlUnit and two driver modules are used. Optionally, the control system can be expanded with additional fieldbus interfaces.

The aflex control provides following interfaces for superior control:

- Digital input/output
- TCP/IP Telnet
- Profibus (optional)
- EtherCAT (optional)
- Profinet (optional)
- EtherNet/IP (optional)

Functional description aflex 400 lv

On the aflex, the components are separated and singled by vibration.

The components are fed to the aflex as bulk material. Usually a hopper system is used for this purpose. A camera system is used to determine the valid pickup coordinates and the component is removed by a handling system.

The aflex is adapted to the components using the "aflexConfigurator" software. Different configurations can be created for different components.

Communication with the higher-level controller is also parameterized in the "aflexConfigurator".

To control the aflex, the selected configuration and the intensity of the control are transmitted to the aflex controller.

To achieve the most cycle-time efficient implementation possible, the aflex is operated with the shortest possible control time. This should be just long enough for the components to reorient themselves. It is more effective to separate several times briefly and to take camera pictures in between than to separate once for a long time.

2.2 Technical data

Figure 1: Dimension sheet aflex

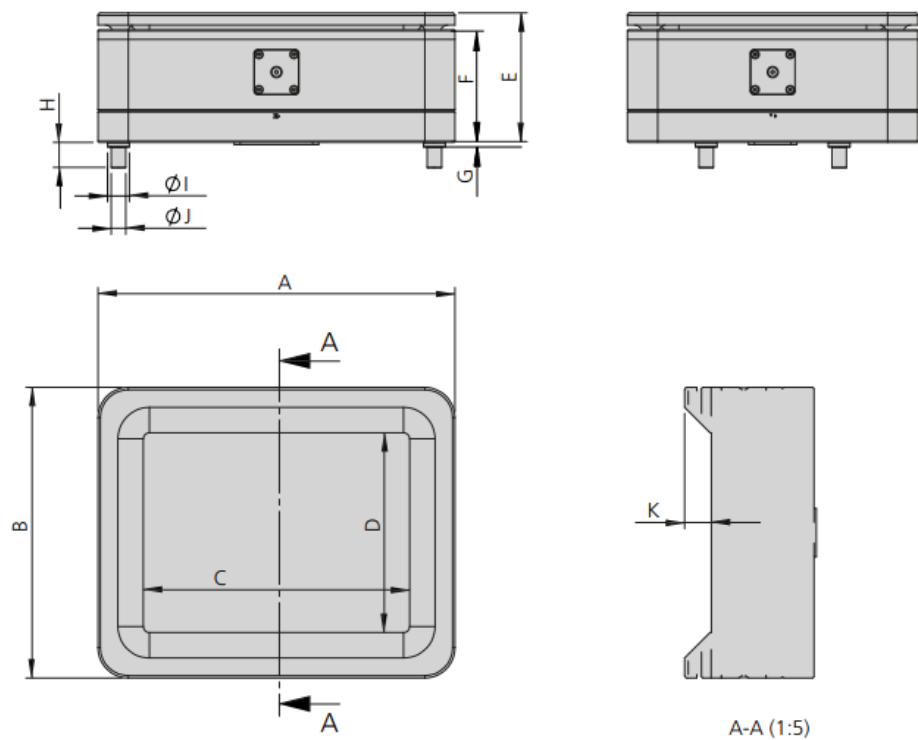

Table 1: Technical data aflex 400 lv

Type	*aflex 400 lv
A	450 mm
B	370 mm
C	330 mm
D	250 mm
E	164 mm
F	143 mm
G	13 mm
H	28 mm
$\varnothing I$	32 mm
$\varnothing J$	10 mm
K	38 mm

Type		*aflex 400 lv
Order number		50540944
Reference value max. size of parts		100 mm
Reference value max. weight of parts		150 g
Conveying directions**		z
Colour of background lighting		white
Control voltage		24 VDC
Total current [max]	(SoftRelease inactive)	15 A
Total current [max]	(SoftRelease active)	25 A
Relative activation duration of the actuators		< 15 %
Operating temperature		0...45°C
Net weight		4 kg
Protection type in closed condition		IP51
Supply line		24xAWG22
Diameter of supply line		11.6 mm
Bending radius of moved supply line		15 x line-Ø
Bending radius of fixed supply line		4 x line-Ø
Vibrating force compensation		yes

Figure 2: Dimension sheet plate for transported material

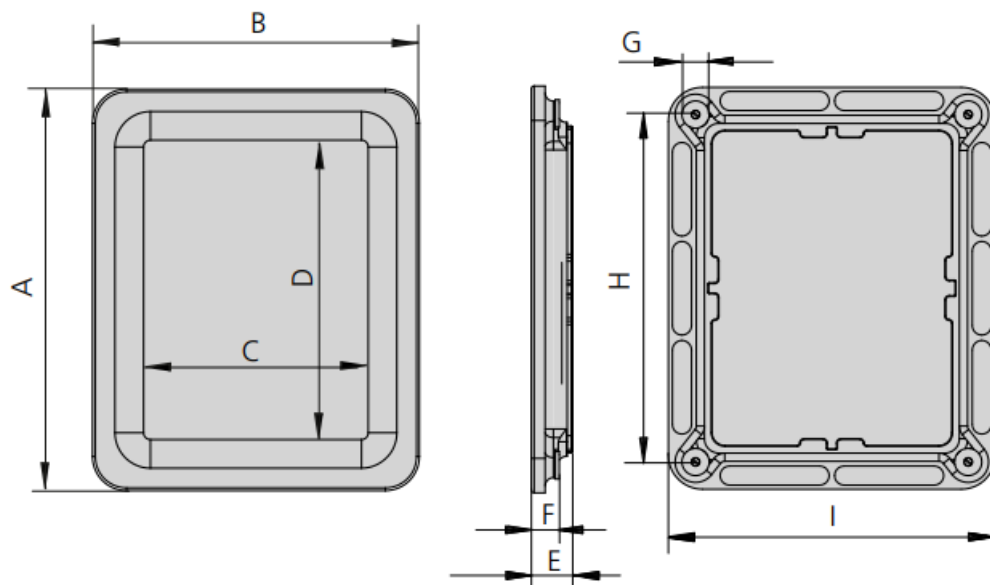

Table 2 : *Technical data of plate for transported material*

Type	aflex 150 qc conveyor plate POM	aflex 200 qc conveyor plate POM	aflex 400 lv conveyor plate POM
A	210 mm	295 mm	450 mm
B	160 mm	240 mm	370 mm
C	100 mm	165 mm	250 mm
D	150 mm	220 mm	330 mm
E	21 mm	30 mm	48 mm
F	13.2 mm	20.3 mm	40 mm
Ø G	16 mm	20 mm	32 mm
H	176 mm	255 mm	360 mm
I	126 mm	200 mm	280 mm

Table 3: *Technical data of the overall system (aflex 400 LV)*

Description	Symbol	Unit	Values
Working voltage DC smoothed	V _{CC}	[V]	23 ... 25
Total current (SoftRelease inactive)	I _T	[A]	Max. 15
Total current (SoftRelease active)	I _T	[A]	Max. 25

Table 4: *Technical data of the background lighting*

Description	Symbol	Unit	Values
Working voltage DC smoothed	V _{CC}	[V]	23 ... 25
colouring white		[K]	5600 (C _x =0.33, C _y =0.33 by CIE 1931)
Surrounding temperature		[°C]	0 ... 45

Table 5: *Technical data of the control unit*

Description	Symbol	Unit	Values
Working voltage DC smoothed	V _{CC}	[V]	23 ... 25
Reverse polarity protection Voltage supply			Yes
Signal voltage "1" Digital output	V _{DO}	[V]	(V _{CC} - 1.0) ... (V _{CC} + 0.5)
Signal voltage "0" Digital output	V _{DO}	[V]	0 ... 1
Output current Digital output	I _{DO}	[mA]	Max. 4
Input voltage Digital output	V _{DI}	[V]	20 ... 30
Input current Digital output	I _{DI}	[mA]	10 ... 10.5
Reverse polarity protection Digital input/output			Yes
PWM Power output	V _{OUT}	[V]	(V _{CC} - 0.5) ... (V _{CC} + 0.5)
Pulse width Power output		[%]	0 ... 100
Frequency power output	F _{OUT}	[kHz]	39.7 ... 40.3
Output current Power output	I _{OUT}	[A]	Max. 4
Reverse polarity protection Power output			No
Operation/Storage temperature		[°C]	+0 - +40 °C / +0 - + 85.+°C
Relative humidity			max. 40% without condensation
Protection class			IP 30

Table 6: *Technical data of the driver unit T4X*

Description	Symbol	Unit	Values
Working voltage DC smoothed	V _{CC}	[V]	23 ... 25
Reverse polarity protection Voltage supply			Yes
Output voltage Output	V _{OUT}	[V]	(V _{CC} - 0.5) ... (V _{CC} + 0.5)
Output current Output	I _{OUT}	[A]	Max. 4
Pulse width Output		[%]	0 ... 100
Frequency output	F _{OUT}	[Hz]	6 ... 200
Reverse polarity protection Power output			No
Operation/Storage temperature		[°C]	+0 - +40 °C / +0 - + 85.+°C
Relative humidity			max. 40% without condensation
Protection class			IP 30

Table 7: *Technical data of the Profibus module PB node*

Description	Symbol	Unit	Values
Working voltage DC smoothed	V _{CC}	[V]	23 ... 25
Reverse polarity protection Voltage supply			Yes
Operation/Storage temperature		[°C]	+0 - +40 °C / +0 - + 85.+°C
Relative humidity			max. 40% without condensation
Protection class			IP 30

Table 8: *Technical data of the EtherCAT, EtherNet/IP and the Profinet modules*

Description	Symbol	Unit	Values
Working voltage DC smoothed	V _{CC}	[V]	23 ... 25
Reverse polarity protection Voltage supply			Yes
Operation/Storage temperature		[°C]	+0 - +40 °C / +0 - + 85.+°C
Relative humidity			max. 40% without condensation
Protection class			IP 30

2.2.1 Maximum size of the parts

A fixed specification of the maximum part size can not be given. The maximum part size depends on the optimum part number for the process.

This number of parts is to be determined empirically, depending on the orientation behaviour and the accessible process.

The most stable process is generally achieved when the accessible surface is covered with components up to a maximum of 2/3.

2.2.2 Maximum part weight

A fixed specification of the maximum part weight cannot be given. The limiting weight depends on the component geometry and the material. If the components are too heavy, they cannot be reoriented reliably for the process.

Components should always be tested in advance for suitability.

2.3 Electrical/Control Components

INSTRUCTION	
	<p>Work on the electrical supply can only be done by qualified personnel.</p>

Figure 3: Overview of electrical components

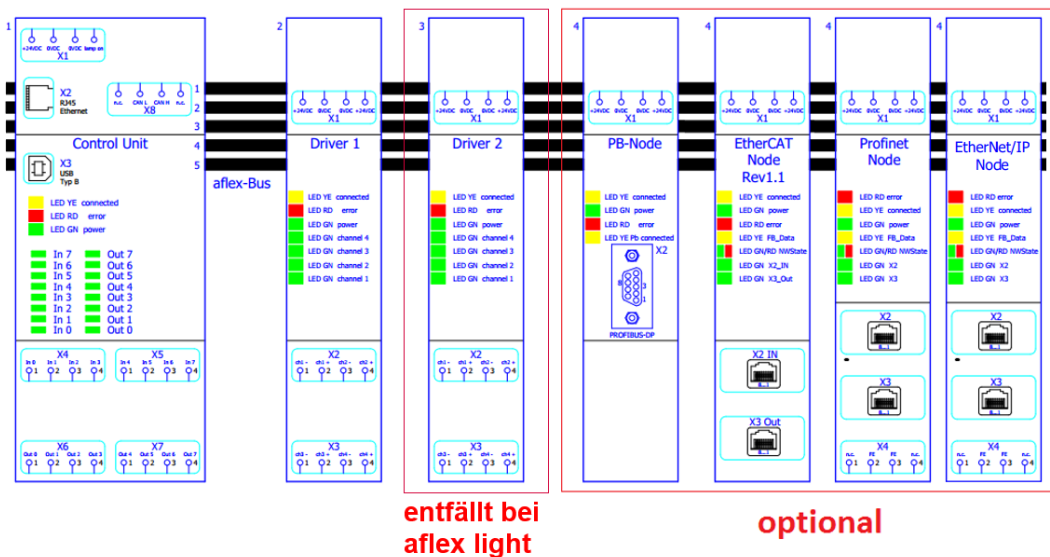

- Control Unit: Intelligence and memory of the aflex controller
- Driver units: Outputs for controlling the aflex actuators
- PB-Node: Optional field bus interface
- EtherCAT Node: Optional field bus interface
- Profinet Node: Optional field bus interface
- EtherNet/IP Node: Optional field bus interface

All control modules communicate via a BackSideBus which is mounted in a standard 35x7.5mm DIN rail. DIN rail and BackSideBus are included in the scope of supply.

INSTRUCTION	
	<p>For reasons of copyright protection, it is not permitted to copy, modify, decompile and/or decompile the control software and create derived programs through it. Exceptions require our express approval.</p>

3 Installation instructions

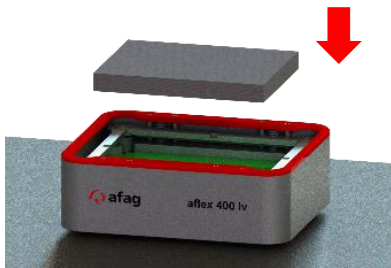

3.1 Transport

The aflex 400 lv may only be transported with the quick-change plate installed. If no quick-release plate is installed, at least the foam protection provided must be used, see following figure.



If control modules are transported individually, the bus contacts must not be damaged. When transporting the control unit in the assembled state, care must be taken to ensure a free of play packaging. Otherwise there is a risk that the control modules will come off the bus rails during transport and carry permanent damage.

The transport packaging supplied must be used.

 WARNING	
	<p>Improper use of transport equipment (floor conveyors, indoor crane, help aids, slings, etc.) can lead to bruises and other injuries. Required behaviour:</p> <ul style="list-style-type: none">▪ Observe and comply with transport and assembly instructions▪ Use appropriate means of transport

3.2 Assembly of the device

To enable the aflex to work with reliable functionality, follow the steps below. In case of non-observance a fault-free operation can not be guaranteed.

3.2.1 Drilling picture for assembly

Figure 4: Drilling picture in assembly level

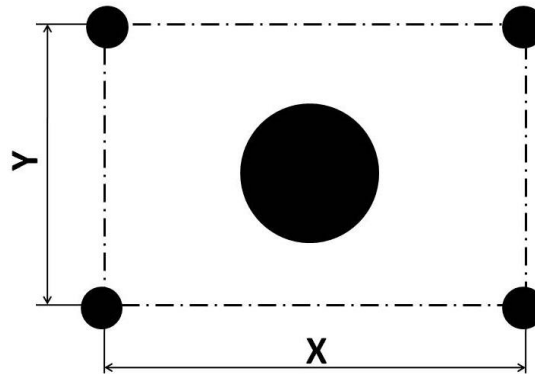

Table 9: Size for drilling picture

Description	Aflex 400 lv
Drilling distance X in [mm]	396
Drilling distance Y in [mm]	180
Diameter of the central bore in [mm]	100
Diameter of the 4 fixing bores in [mm]	M10 internal thread

3.2.2 Dimensions of the base plate

If the substructure on which the aflex 400 lv is mounted is too weak, the vibrations are transmitted to it more strongly. This dampens the vibration of the aflex conveyor plate.

Therefore, care should be taken to ensure that the substructure is sufficiently stable. As a guide, the substructure should have a dead weight of at least 100 kg. The substructure should also have sufficient floor space, at least 1m² of floor space can be used as a guide here.

3.2.3 Assembly on base plate

Insert the aflex with the four Flex bushings into the holes of the system base plate. Observe the orientation of the device with regard to the subsequent cable connection.

Figure 5: Assembly on base plate

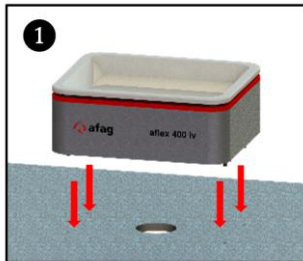

3.2.4 Dismantling the funnel plate

In order to fix the aflex on the base plate, the flex bushings must be tightened. Dismantle the funnel plate with the provided plastic wedge.

INSTRUCTION	
	<p>Please use only the dismantling wedges for the dismantling process of the funnel plate!</p>

Insert the wedges into the gap between the white and the red plate.

First, press the two wedges together to tilt them outwards in a rotary movement.

The funnel plate is thereby detached from the magnets and can be removed.

Figure 6: Motion sequence dismantling funnel plate with assembly wedges

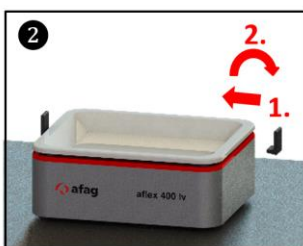
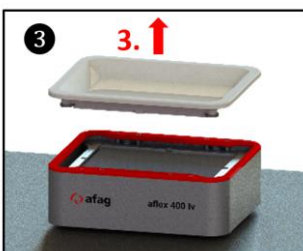

Figure 6: Remove funnel plate



3.2.5 Tighten Flex sockets

The Flex sockets should have been tightened using the supplied 5mm wrench socket, a torque wrench and corresponding to the sequence shown below.

Figure 7: Tighten Flex sockets

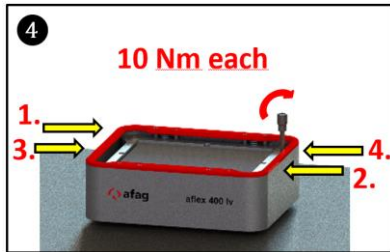

INSTRUCTION	
	<p>Observe the following:</p> <ul style="list-style-type: none"> - Maximum torque 10Nm - Suitable mounting level, see chapter 3.2.2

3.2.6 Remove transport safety

Remove the transport safety using a metallic object.

Figure 8: Remove transport safety

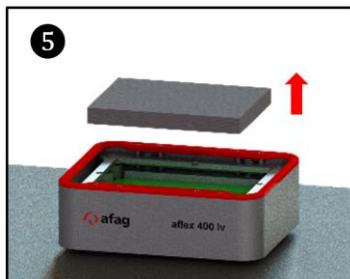

3.2.7 Install funnel plate

Re-install the funnel plate from top of the aflex. Observe the different openings on the funnel plate or on the aflex itself during this.

Figure 9: Install funnel plate

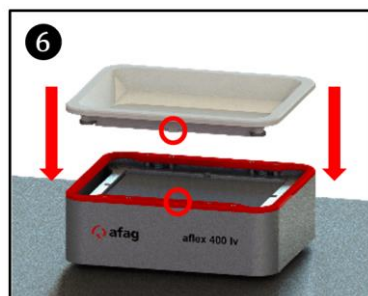



3.3 Connection of the device

The aflex 400 lv is supplied via the 26 poles D-Sub-plug connector of the supplied connecting cables (5m). The allocation pin can be found in the supplied circuit plan.

Figure 7: Connection from bottom



3.4 Power supply

 WARNING	
	<ul style="list-style-type: none">▪ Work on the electrical supply may only be carried out by trained, authorized qualified personnel!▪ The grid feed must take place on the customer's side via a residual current circuit breaker!▪ The aflex may only be driven with 24V DC.

The energy feed of aflex takes place with 24V DC low-voltage. The energy supply must be made available by the operator.

The exact specification is available in the chapter *2.2 Technical data*.
The assembly may only be carried out by a qualified personnel.

3.5 Connection of the control

All modules of the control are mounted on a profile rail with BackSideBus. The modules are fixed via end terminals and the terminating resistors of the BackSide-Bus are thus protected. Below is a drawing of the controller. The profile rail is delivered with a length of 142.0 mm, the BackSideBus with a length of 123.0 mm.

Figure 8: Drawing Control modules

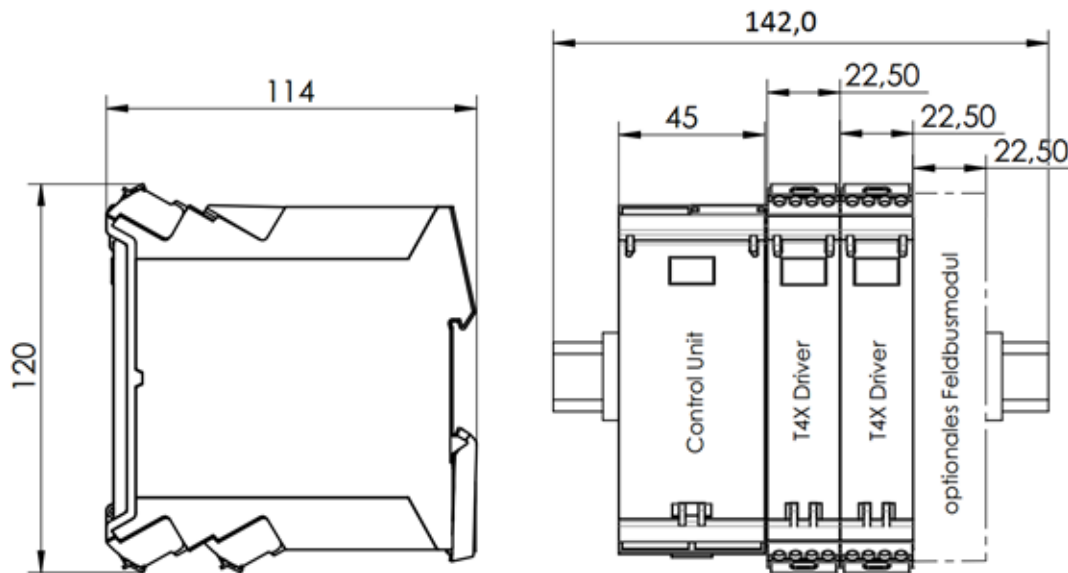

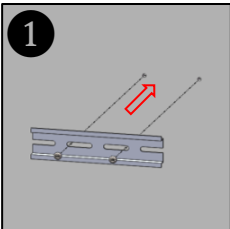
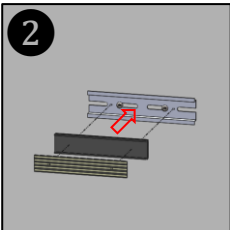

The control is sent in the mounted state; it is possible to install the profile rail in the control cabinet without dismantling. Alternatively, the control modules can be dismantled. For subsequent reassembly, observe the following procedure:

3.5.1 Building the control module

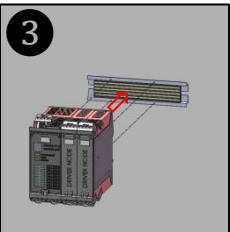
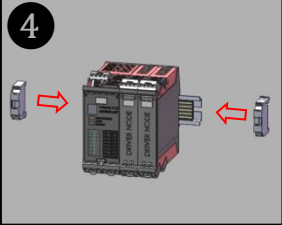

 <p>1</p>	<p>Mount the profile rail in the control cabinet, the screw head height must not exceed 3.8 mm.</p>
 <p>2</p>	<p>Fasten the bus circuit board using the corresponding circuit board cover.</p>

 <p>3</p>	<p>Now place the individual control modules on the profile rail. Make sure that the housings are not jammed and the contacts to the BackSideBus are not bent.</p>
 <p>4</p>	<p>Mount the profile rail end brackets TS35 so that the terminating resistors of the bus rail are protected and the control modules are fixed.</p>

3.5.2 Electrical Connection aflex 400 Iv

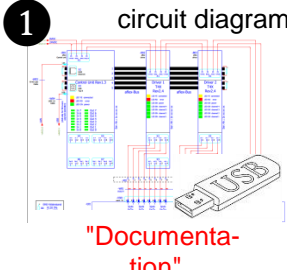
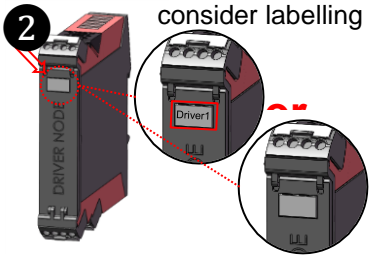
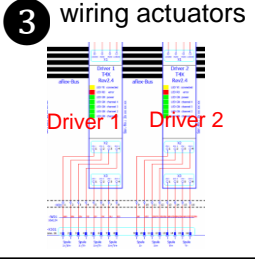
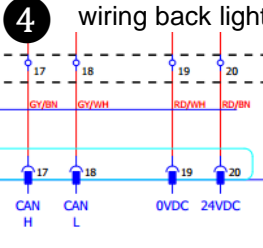
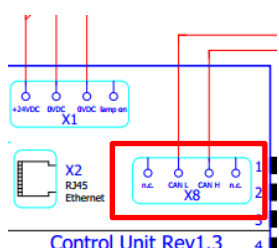
INSTRUCTION	
	<p>It is possible to separate the screw terminals of the modules from the housing via the clip lock in order to connect the lines. However, do not interchange the individual terminals.</p> <div style="display: flex; justify-content: space-around; align-items: center;">   </div>

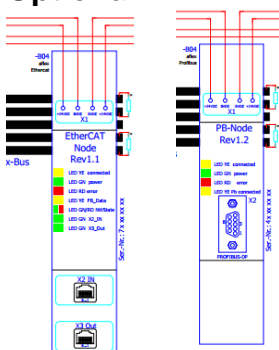
<p>1 circuit diagram</p>  <p style="color: red; text-align: center;">"Documenta- tion"</p>	<p>Open the delivered circuit plan with USB stick. The circuit plan is found in the "documentation".</p>
<p>2 consider labelling</p> 	<p>When connecting the driver modules, make sure that they are labelled "Driver 1" and "Driver 2". The control is preconfigured with this assignment.</p>
<p>3 wiring actuators</p>  <p style="color: red; text-align: center;">Driver 1 Driver 2</p>	<p>Connect the aflex cable, in the best case, to the control modules via a terminal strip.</p>
<p>4 wiring back light</p> 	 <p>Supply the aflex back light according to the circuit diagram with 24V DC and connect the CAN signals to the ControlUnit.</p>

<p>Optional:</p> 	<p>Connect optional fieldbus interfaces according to the circuit diagram.</p>
<p>5</p> 	<p>Connect the aflex via the connector on the bottom of the device</p>

4 Software description

INSTRUCTION	
	<p>This operating manual describes the software "aflexConfigurator" as from version v2.0</p>

The following section describes the "aflexConfigurator" in detail.

The control is set up and preconfigured to the desired application via this Windows application.

The aflexConfigurator is used to set the aflex on the components to be fed.

Figure 9: aflexConfigurator Start page

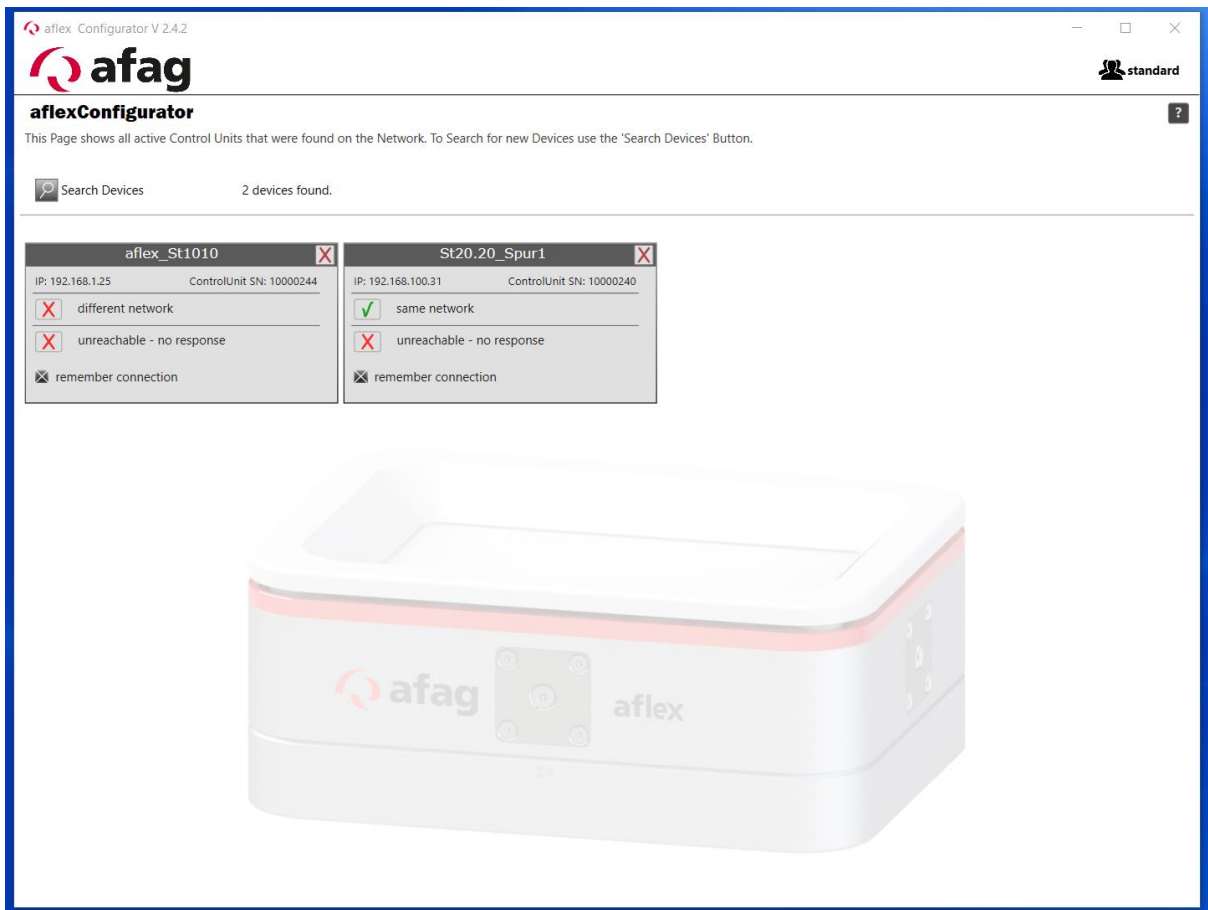

4.1 Installation of the Software

Install the software included in the scope of delivery. To do this, run the "setup.exe" and follow the installation instructions.

After the "aflexConfigurator" is successfully installed, start the application.

4.2 User groups

To enable easier operation for the standard user, complex functions are distributed to different user levels. The current user group is displayed in the upper right of the aflex-Configurator.

Figure 10: Display the current user



Clicking on this button changes the user group.

Figure 11: User switching

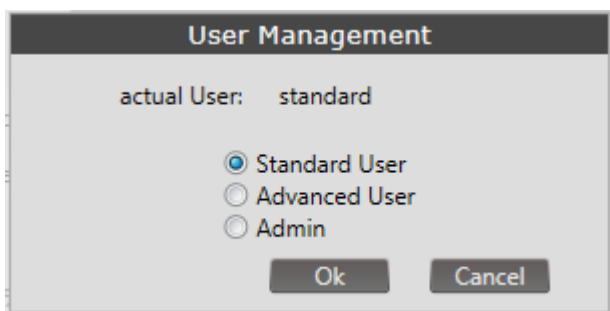

User: "Standard"

Basic functions for manual operation of the aflex system

- Can not make permanent changes, saving is deactivated
- Can load configurations and test their function

User: "Advanced"

Contains extended rights against the "standard" user. This user group is used for commissioning the aflex system.

- Has the right to change and save configurations
- Can change general settings and save them
- Has access to the "fieldbus menu"

The advanced user is password-protected. The password is not changeable.

The password for the user "advanced" is "1".

User: "Admin"

Has full access rights in the aflexConfigurator. Can parametrize aflex modules and change basic settings. This user is only to be used when exchanging modules.

The "admin" user is password-protected. The password should be determined from the manufacturer.

INSTRUCTION	
	<p>The user "admin" has full access rights. In case of improper operation, the function of the aflex system is impaired or lost.</p>

4.3 Start page

When the program is started, the start page opens, this is shown in the following figure.

➔ Start the "aflexConfigurator".

Figure 12: Overview window

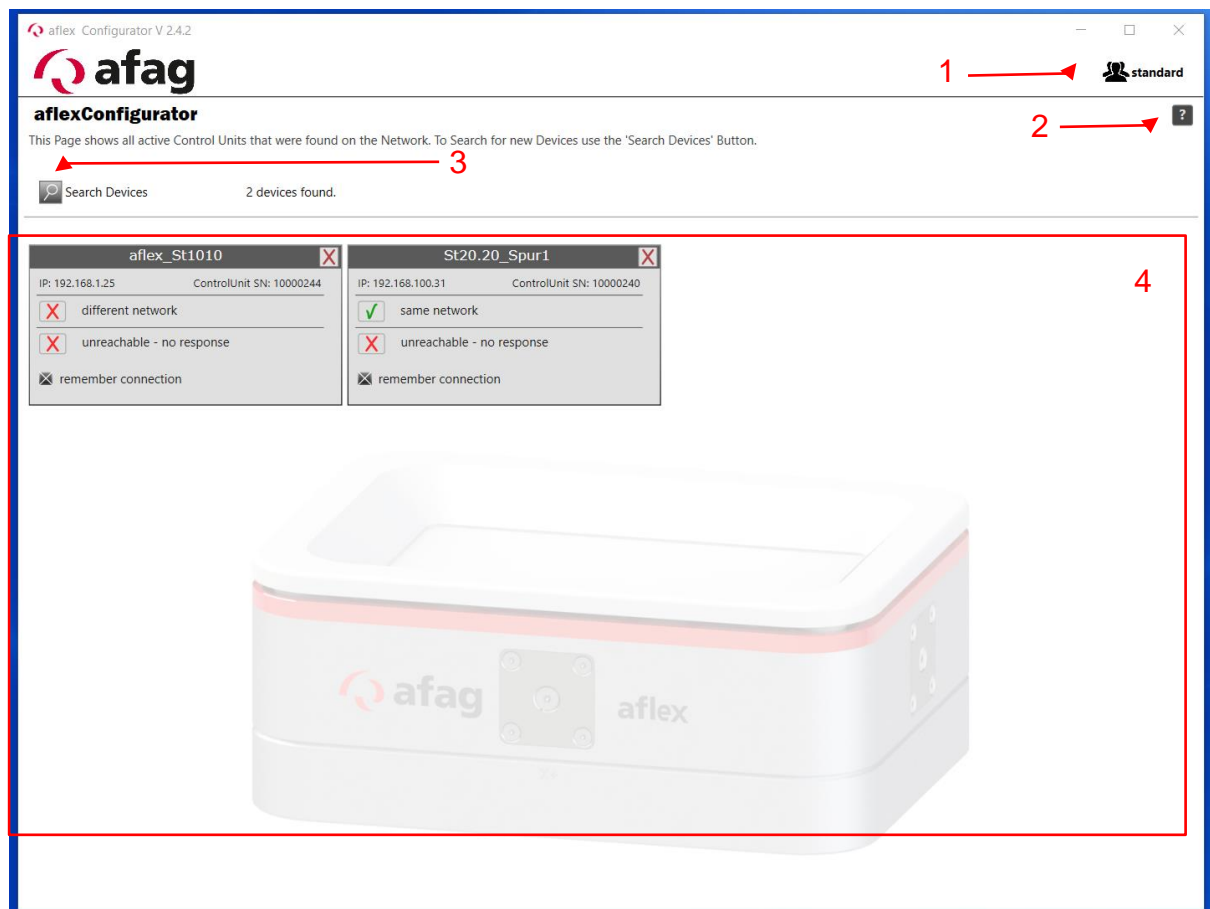

(1) User switching

- (2) Help page
- (3) Search for devices in the network
- (4) Display the control unit

In order to establish a connection to the control unit of the aflex controller, this must be connected to the computer via Ethernet interface.

→ Connect the controller to the computer's network.

User switching (1)

User change for extended display of options. For more information on user groups, see 4.2.

Help page(2)

Display the corresponding extract from the operating manual.

Search Devices (3)

The aflexConfigurator searches for existing ControlUnits in the network using the "Search Devices" button.

The function sends a UDP broadcast message to which the ControlUnits send a response.

The aflexConfigurator must be registered in the firewall so that it can receive the broadcast responses. The corresponding query is executed at the first start after installation.

If the broadcast is blocked by the firewall, a connection can only be established to known IP addresses. Either these are ControlUnits which were found in the past and were stored by the function "remember connection". Or the known IP address of a ControlUnit is added via the function "add ControlUnit". This function is available from the user level "Advanced". This function is described in detail in section 4.3.2.

Display the control units (4)

This field lists the control units found on the network. Also stored control units are displayed from previous program starts.

4.3.1 ControlUnit states

The control units found or stored in the network have different device status properties. These are described below.

Figure 13: Display ControlUnit

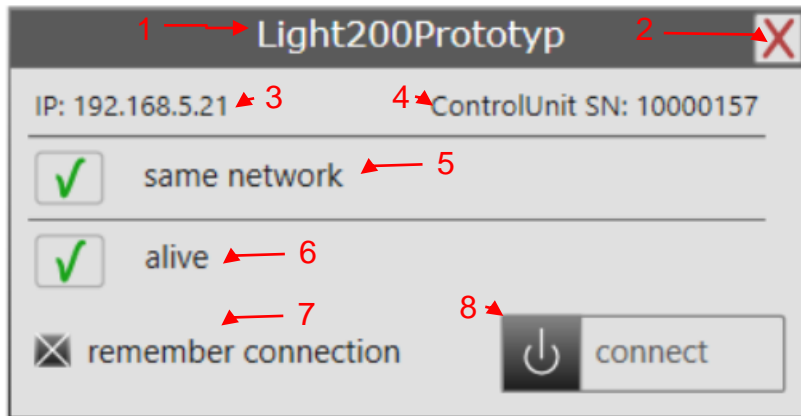

- (1) ControlUnit Name
- (2) Remove ControlUnit from lists
- (3) IP Address
- (4) Series number
- (5) Network status, Subnet
- (6) accessibility Status
- (7) Save ControlUnit
- (8) Establish connection

ControlUnit Name (1)

The name of the ControlUnit can be changed in the aflexConfigurator and the application can be adjusted. This facilitates the identification while using more aflex devices.

Remove ControlUnit (2)

Remove the ControlUnit from the display. If the control unit is located in the same network, it can be found again via "Search Devices".

IP Address (3)

The IP address of the ControlUnit

Series number (4)

The series number of the Controlunit. This can also be found on the housing, in the side inscription field.

Network status, Subnet (5)

To establish a connection to the control unit, the two participants must be found in the same subnet. If the status "different network" is displayed, the IP address of the computer must be adapted to establish a connection.

Connectivity status (6)

If both participants are in the same subnet, the aflexConfigurator addresses the participant cyclically. If the participant is a ControlUnit, it responds and is displayed as "alive". A connection can be established.

If the station responds, "unreachable - no response" is displayed.

Save control unit (7)

Once detected control unit's can be stored for later use in a local file. If the aflexConfigurator is closed, all control unit's with the status "remember connection" are saved. These are loaded when the program is restarted and added to the display. To prevent older control unit's to display automatically, the checkbox "remember connection" has to be removed.

Establish connection (8)

This button starts the connection set-up to the control unit.

The various views of the control unit display are visualized and described below.

Figure 14: Connection not possible, different subnet

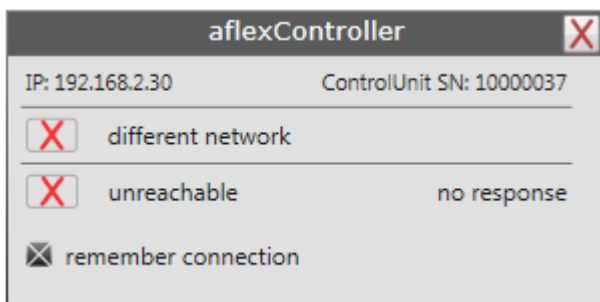

The control unit and computers are located in different subnets. The IP address of the computer must be adapted to establish a connection. In this example, click on the "192.168.2.xxx" section.

Figure 15: missing ping response

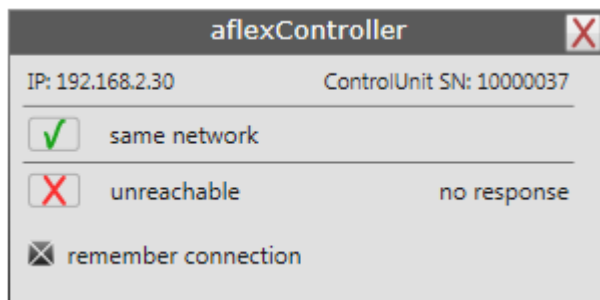

The control unit and the computer are located in the same subnet and the control unit is contacted by the computer. However, a valid response is missing. This can have the following causes:

- The control unit is switched off
- The network connection has been interrupted.

Figure 16: Control unit ready for connection set-up

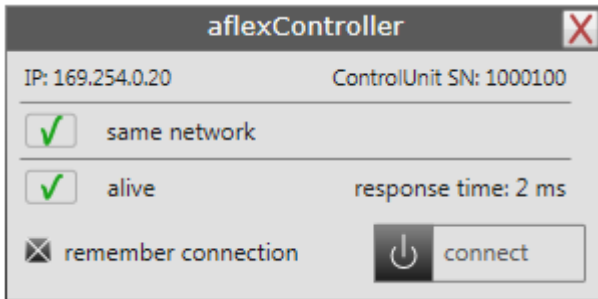

The control unit delivers a valid response. The response time is displayed. The connection set-up is started via the "connect" button.

4.3.2 Advanced display for Advanced user

If the user "admin" or "advanced" are activated, further displays and options are visible on the start page. These are described below.

Figure 17: Start page display advanced

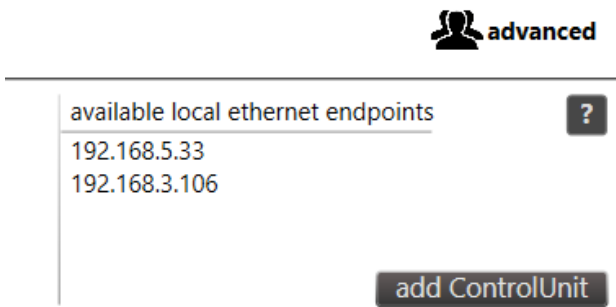

In Advanced mode the local Ethernet endpoints of the computer are displayed. These are used to search for devices in the network via UDP broadcast and direct messages.

4.3.2.1 Function "add ControlUnit"

It is also possible to add a ControlUnit with a known IP address without the UDP broadcast using the "add ControlUnit" function.

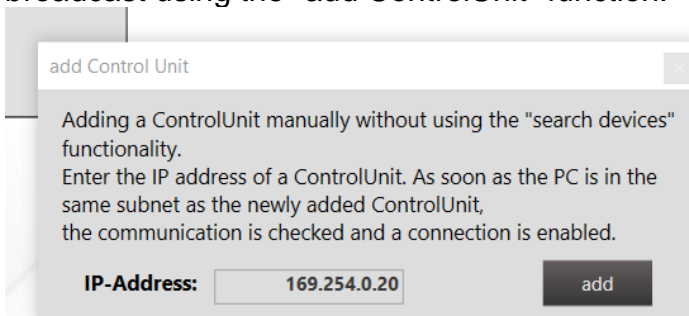

The ControlUnit added in this way is displayed with the name "addedoffline" and serial number "0" until the first communication.

4.3.3 Extended display Administrator

With the user level Administrator, the MAC address of the found ControlUnit's is displayed.

Figure 18: *device Display administrator*

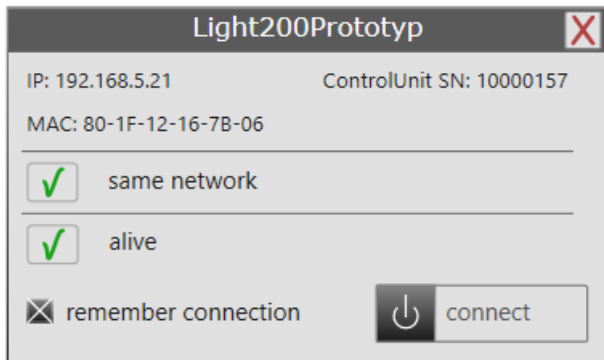

4.3.4 Connection set-up

After pressing the "connect" button the TCP/IP connection is established and the data of the control unit is read out.

Figure 19: *Connection set-up*

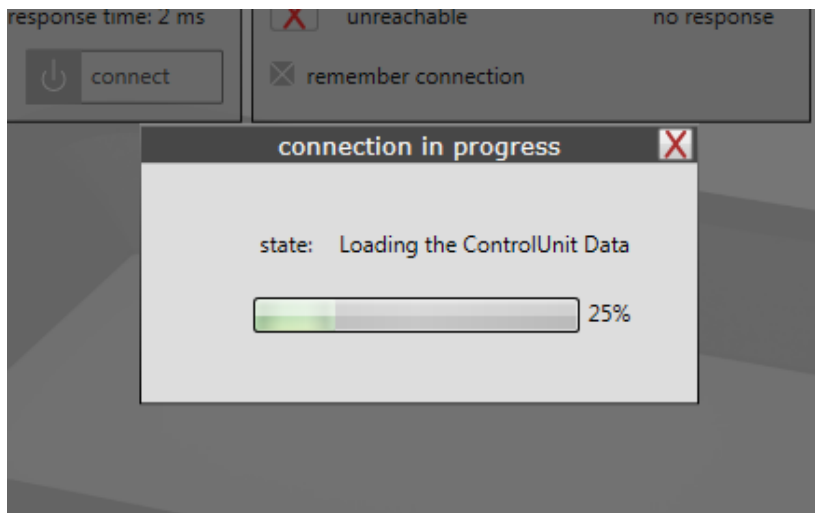

If another aflexConfigurator is already connected to the control unit, no TCP/IP connection is established. The connection attempt is terminated after expiry of the time-out time.

4.4 Main menu

After successful connection the menu "control interface" is displayed.

Figure 20: Control interface



Figure 21: Main menu

Figure 22: Main menu extended view

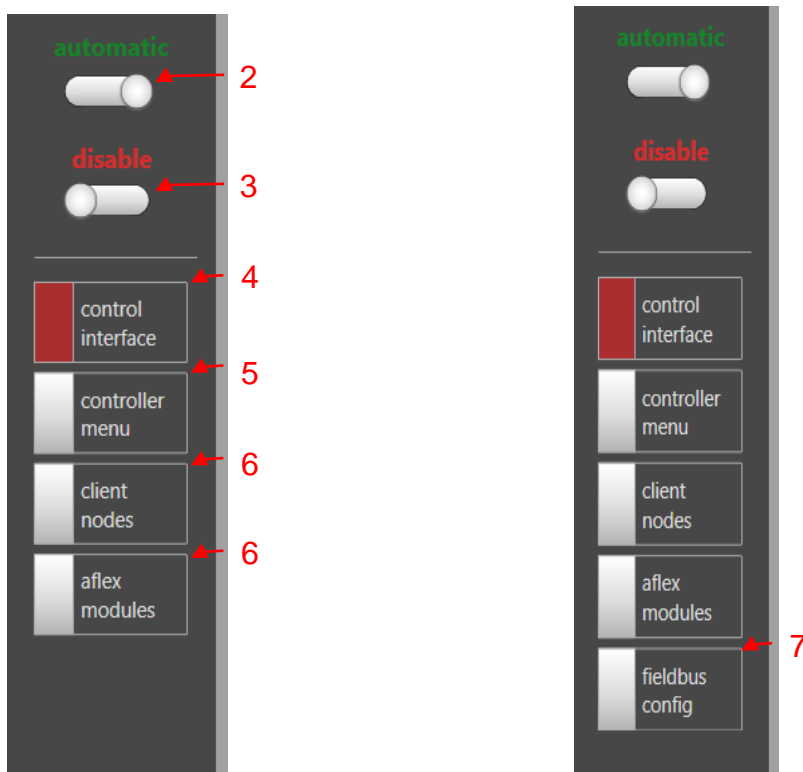

- (1) Operating mode
- (2) Release
- (3) control interface

- (4) controller menu
- (5) client nodes
- (6) aflex modules
- (7) fieldbus config

Operating mode (1)

The current operating status is given back on the display status. The sliding button can be used to toggle between automatic/manual modes.

Automatic operation:

In automatic mode, the aflex control responds to commands from the higher-level controller. These are transmitted via the fieldbus interface. As long as the automatic mode is active, no commands can be executed from the "aflexConfigurator". The "aflexConfigurator" generates an error message in this case.

- After a restart, the aflex control is found in the automatic mode.
- The aflex controller automatically switches to automatic mode when the connection to the "aflexConfigurator" is interrupted.
- If the control unit is in manual mode, it can not be set to the "automatic mode" via the fieldbus interface. The aflexConfigurator takes precedence. If the aflexConfigurator is closed and the connection is interrupted, the control unit automatically changes to the "automatic mode".

Manual mode:

In the manual mode, the aflex control processes only commands from the "aflexConfigurator". Commands via the fieldbus interface are blocked and not processed.

Release (2)

The aflex controller requires a general release to switch power outputs. This can be set with a command from the fieldbus interface or the button "General Release" (10). If the release is set to "0", all power outputs are disabled. The background lighting and all aflex actuators are switched off. The current release is displayed by the status (1). If a release exists, this is displayed with "released", otherwise with "inhibit".

Control interface (3)

The menu "control interface" provides all functions for the manual operation of the aflex. These are described at section 4.5 in more detail in the section.

Controller menu (4)

Settings of the control unit are made here. These are, for example, network settings, data backup or the configuration of the telnet interface. A detailed description can be found in the section 4.6.

Client nodes (5)

Settings of the various control modules exclusive to the control unit. This is also referred to as client nodes. The corresponding description is in the section 4.7.

Aflex modules (6)

Setting the aflex module, such as the client node assignment. For information, please refer to the section 4.9.

Fieldbus config (7)

Configuration of the fieldbus interface. This menu is only visible from the user level "advanced". Information on this menu can be found in the section. 4.8

Figure 23: *Disconnect active connection*



- (1) User switching
- (2) Return to home page

User Switching (1)

User change for extended display of options. Further information on the user groups can be found in the section 4.2

Return to home page (2)

Deletes the connection to the current control unit and returns to the start page.

4.5 Control interface

The menu "control interface" provides all functions for the manual operation of the aflex.

INSTRUCTION	
	<p>The operating mode "manual" is a prerequisite for controlling the aflex via aflexConfigurator.</p>

4.5.1 Aflex control panel aflex 400 lv

The aflex control panel is used to manually control and configure the aflex control panel.

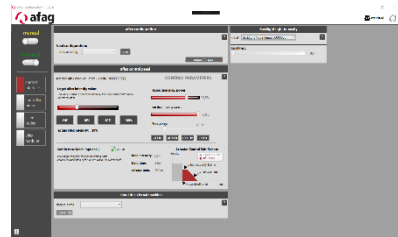



Figure 24: aflex control panel

aflex control panel

CONTROL PARAMETERS ?

selected aflex module: aflex lv (Serial: 1000000000)

target aflex intensity value:
This value is used in automatic mode by the higher-level controller to control the aflex



Off
-10%
+10%
100%

actual aflex intensity: 30% ← 2

absorption max. power: ▲ 4



vertical max. power: ▲ 5



Frequency: 43 Hz ▲ 6

-1 Hz
-0.1 Hz
+0.1 Hz
+1 Hz

Soft Release Mode [optional] inactive ← 7

Optional functionality for long oscillating parts. Reduces the oscillation of the system when it is switched off.

hold intensity: 63% 8

hold time: 54ms

release time: 197ms

Actuator Control Soft Release

intensity



normal operation

soft release

- (1) Set aflex intensity
- (2) Display: current intensity
- (3) Help page
- (4) Absorption max. power
- (5) Vertical max. power
- (6) vertical phase
- (7) set aflex frequency
- (8) status soft-release activated
- (9) status soft-release settings

set aflex intensity(1)

Specifies the aflex intensity. This setting controls the aflex in the "manual" operating mode. In the "automatic" operating mode, this value is specified by the higher-level controller. The default value can be changed using the slider or the key.

actual aflex Intensity (2)

Actual aflex intensity value

Help page(3)

Display of the corresponding excerpt from the operating manual.

Absorption max. power (4)

This slider changes the attenuation characteristics of the aflex 400 lv. The damping actuators are operated parallel to the vertical actuators and influence the strength of the vibrations that are transmitted to the outside of the base plate.

The slider determines in which intensity range the damping actuators are actually operated. The specified aflex intensity (1) is converted to the range 0 - "absorption max. power".

If the slider is set to e.g. 80%, the attenuation actuators are actually controlled from 0-80% by the preset intensity of 0-100%.

Vertical max. power (5)

This slider changes the vertical actuators of the aflex 400 lv.

The vertical actuators control the oscillation of the hopper plate and influence how much the components on the aflex are moved.

The slider determines in which intensity range the vertical actuators are actually operated. The given aflex intensity (1) is converted to the range 0- "absorption max. power".

If the slider is set to e.g. 80% the damping actuators are actually controlled from 0-80% by the preset intensity of 0-100%.

Lock intensity ratio display

Starting from the user level "Advanced" the intensity ratio between vertical actuators and damping actuators can be locked.

The symbol shown below is used for this purpose. By clicking on it, the dependency is activated or deactivated.

By means of this function, the maximum strength of the system can be limited without changing the damping ratio.

Figure 25: lock intensity ratio

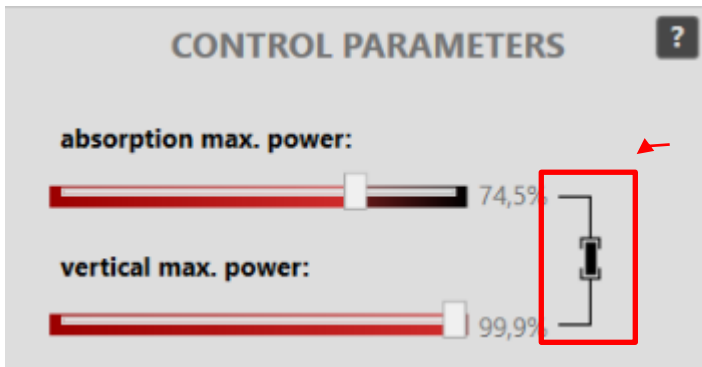

Frequency (6)

This function is used to parameterize the oscillation frequency of the aflex. The setting can be changed using the sliders and the buttons.

The vibration frequency has a significant influence on the behavior of the components on the aflex. The resonance frequency of the oscillating plate is usually selected for separating the components.

Status Soft-Release activated (7)(8) User "standard"

The display of the "Soft-Release" functionality depends on the user level. As user "standard" only a display of the soft-release is integrated. It is displayed whether the "soft release" is active or not.

Display active:

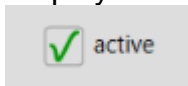

Display inactive:

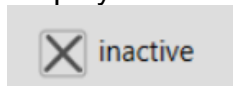

Details on the soft release are explained in the following section.

4.5.1.1 "Soft-Release"

In order to minimize the oscillation of the components after the control, the soft release can be used. This function depends on the component and is not necessary for every component. Since this function extends the cycle time of the system, it should only be used if necessary.

The soft release is stored in the aflex configurations like all parameters of the aflex control panel. Depending on the parameterization, the soft release is used or not during a configuration.

The aflex actuators are controlled after the system is switched off (falling edge of the aflex "Intensity") for the set times as shown in the diagram below.

Figure 26: diagram soft-release

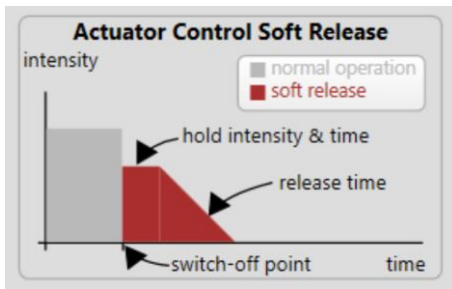
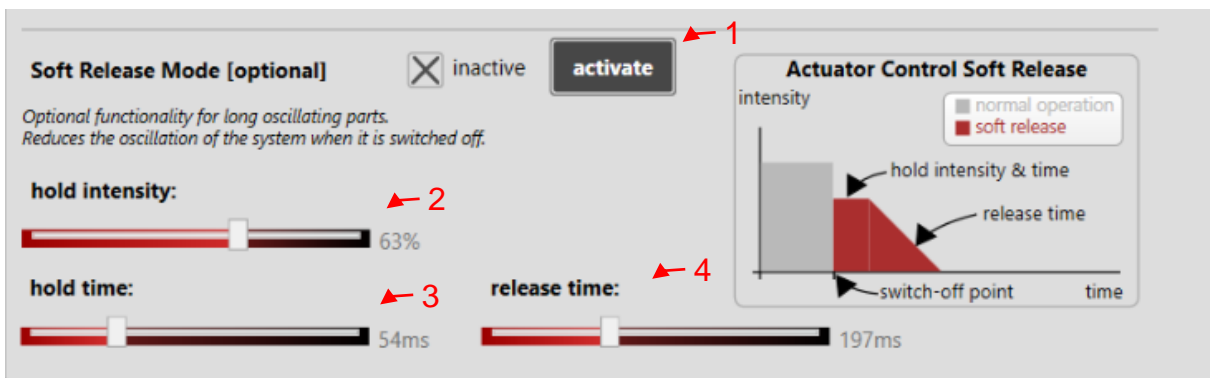

Figure 27: Parameterization Soft Release. Visibility from user level "advanced"



- (1) Enable/Disable Soft-Release
- (2) Hold intensity
- (3) Hold time
- (4) Release time

Activate/Deactivate Soft Release (1)

This button is used to activate or deactivate the soft release.

Hold intensity (2)

Specifies how strongly the actuators are controlled in the soft release for the "hold time"

Hold time (3)

Specifies how long the actuators are controlled with the "hold intensity".

Release time (4)

The control of the actuators is reduced linearly via the "release time" until the system is completely switched off

INSTRUCTION	
	<p>If the soft release is set too high, the conveyor plate can be pulled to the mechanical stop and the damping effect of the soft release is lost.</p> <p>In this case, the "hold intensity" and/or the "hold time" must be reduced.</p>

4.5.1.2 Intensity limitation user level "Administrator"

These sliders are used to limit the intensity of the channels of the T4X client nodes used. This intensity limitation is a system setting which is parameterized independently of the component. It is not stored in the "aflexConfiugrations".

While the "Control Parameters" "absorbtion max. power" and "vertical max. power" limit the intensity of the aflex adapted to the components, this limits the basic intensity of the system.

This function can therefore only be set when configuring the aflex system and is only accessible to the "Administrator" user level.

Figure 28: General Settings aflex Intensity, user level "Administrator"

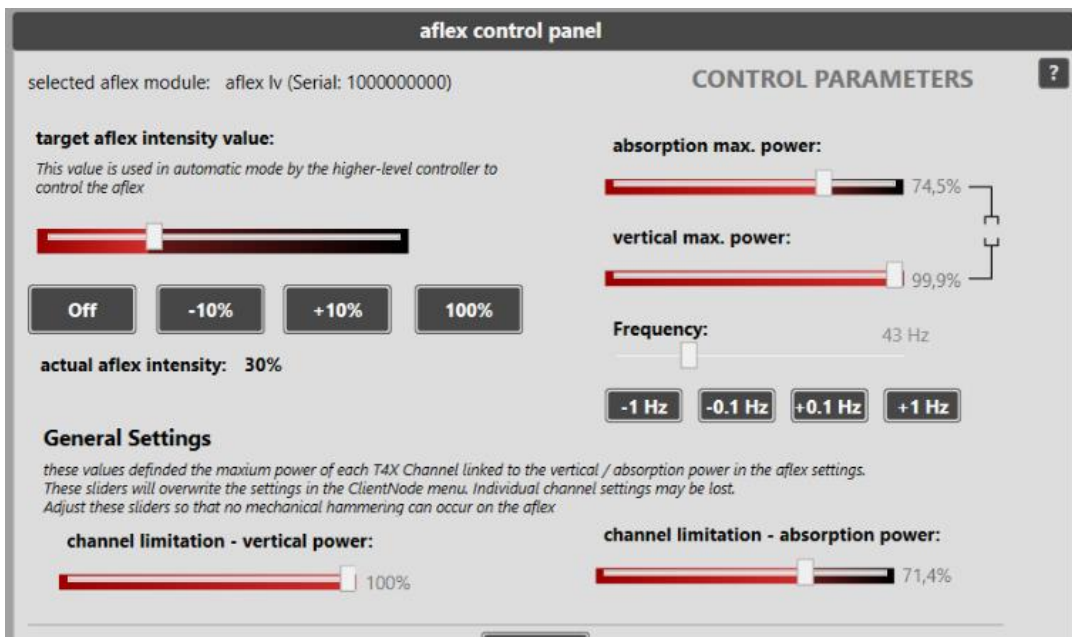

The display of the current intensity can be mapped if all affected T4X channels are parameterized to the same value.

If this is not the case, the following message is displayed:

Figure 29: General Settings, Channel Limitation T4X diff. Values

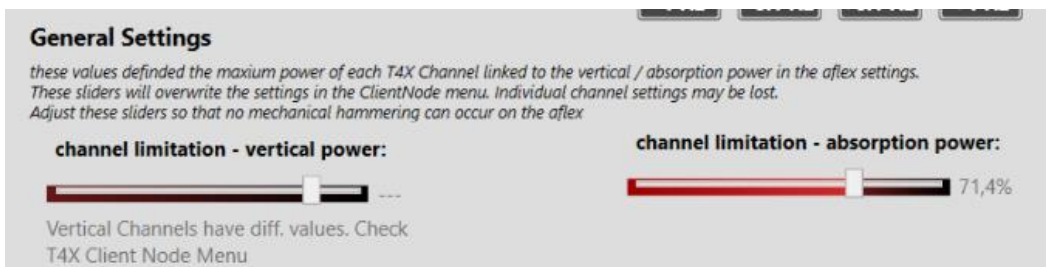

INSTRUCTION



The intensity of the aflex should be limited so that the system cannot vibrate against the mechanical stops.

4.5.2 Aflex configurations

In order to enable different components or movement sequences to be used on the aflex, so-called "configurations" are used. Each configuration contains a parameter set of aflex control. The following parameters are saved:

- *horizontal primary phase*
- *horizontal inverted phase*
- *vertical phase*
- *horizontal maximum power*
- *vertical maximum power*
- *frequency*

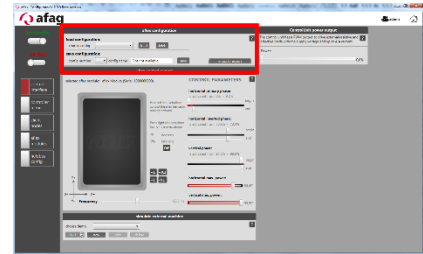

When loading a saved configuration, the current parameters are overwritten with the loaded ones. There is no configuration monitoring, i.e. the parameters are overwritten once, the current parameters are subsequently changed, no automatic correction is carried out. The last loaded configuration is displayed in aflexConfigurator. The fieldbus output "LoadConfigNumber" also shows the last loaded configuration.

The configurations are loaded or saved in the control interface. These functions are described in more detail below.

Figure 30: aflex configuration standard view



Figure 31: aflex configuration advanced view



Figure 32: aflex configuration advanced view



- (1) Available configurations
- (2) Load configuration
- (3) Help page
- (4) Import/Export of Configurations
- (5) Select configuration number
- (6) Configuration name Input
- (7) Save configuration
- (8) Delete configuration

Available configurations (1)

Display saved configurations. Display of configuration number and name.

Load configuration (2)

Load the bottom (1) selected configuration

Help page (3)

Display the corresponding extract from the operating manual.

Import/Export of Configurations (4)

A new window opens in which the parameter records saved in the computer are loaded. The current parameter set can also be stored locally. Only the current aflex parameters are exported or overwritten during import. This must be observed.

INSTRUCTION	
	<p>Import Configuration:</p> <p>The current parameters are overwritten with the imported ones. The imported parameters are not automatically saved as a configuration. If desired, the current parameters must then be stored manually.</p>

Configuration number Selection (5)

From user level "advanced" visible. Select the configuration number which should be saved.

Configuration name Input (6)

From user level "advanced" visible. Entry of the configuration name should be saved. Maximum of 21 characters.

Save configuration (7)

From user level "advanced" visible. Saves the current aflex parameters under the selected configuration number (5) and the entered configuration name (6).

Delete configuration (8)

Visible from user level "advanced". Deletes the selected configuration (1). Configuration numbers 1 & 2 can not be deleted.

4.5.3 Backlight

The slider controls the light intensity of the backlight. The series number of the backlight node is noted. If this is not the case, the power output of the ControlUnit is controlled via the slider.

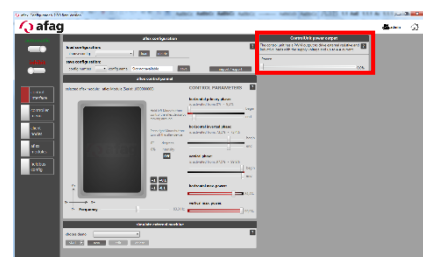

4.5.4 Simulation of the external control

In automatic mode, the aflex should only be operated in short pulses in order to keep the cycle times as low as possible. This function is provided to take account of this pulsed control already during the creation of the aflex configurations. The simulation consists of several control sequences and a pause sequence. Each sequence can be freely parametrized. The simulations, also known as demos, can be edited, exported and imported.

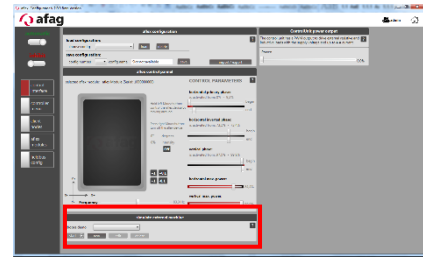

Figure 33: simulate external machine standard view

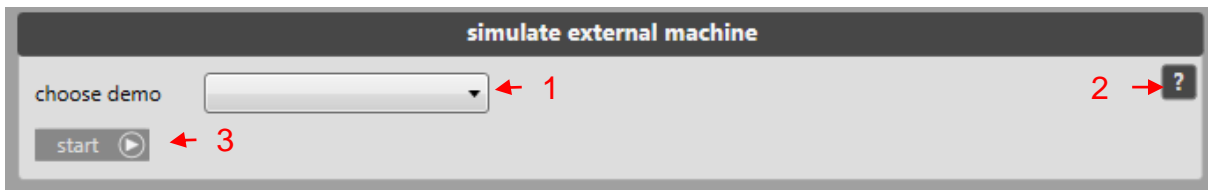
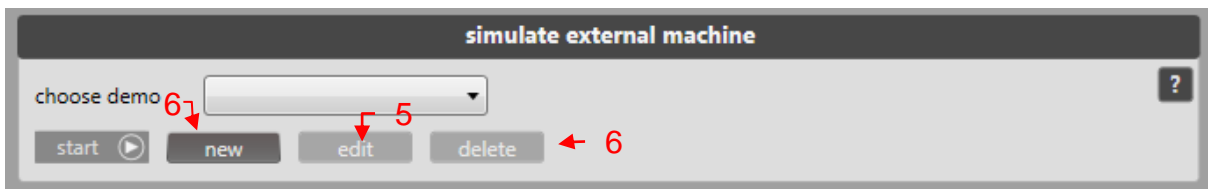

Figure 34: simulate external machine advanced view



- (1) Select a simulation
- (2) Help page
- (3) Start/Stop of the selected demo
- (4) Create a new simulation
- (5) Editing the selected simulation
- (6) Delete the selected demo

Selection of a simulation (1)

Display of saved, available simulations.

Help page (2)

Display the corresponding extract from the operating manual.

Start/Stop a selected demo (3)

Starts or stops the current simulation.

Creating a new simulation (4)

From user level "advanced" visible. Opens the "demo configurator" to create a new simulation. Information on the "demo configurator" can be found in the following section.

Editing the selected simulation (5)

From user level "advanced" visible. Opens the "demo configurator" to edit the current simulation. Information on the "demo configurator" can be found in the following section.

Delete the selected demo (6)

From user level "advanced" visible. Deletes the currently selected simulation.

4.5.4.1 Demo Configurator

The "demo configurator" is used to configure simulations. The individual functions are described in more detail below.

Figure 35: demo configurator

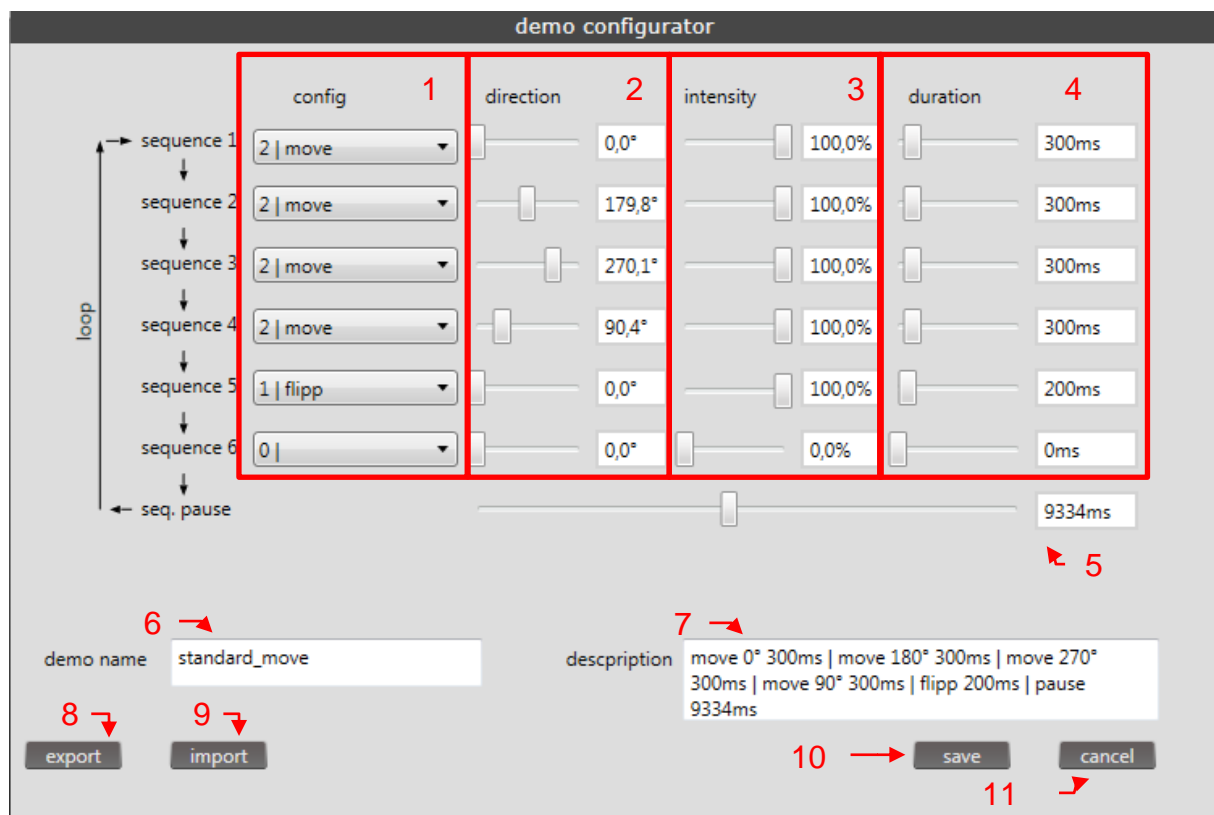

- (1) Select configuration
- (2) Select direction
- (3) Select intensity
- (4) Select duration
- (5) Pause time
- (6) Demo Name
- (7) Description
- (8) Export
- (9) Import
- (10) Save
- (11) Cancel

Select configuration (1)

A different configuration can be loaded in each sequence. If the same configuration is used for the previous sequence, it is not reloaded. If no configuration is selected, there is also no loading process.

Select direction (2)

A different direction of movement is given in each sequence. Entry is possible via slider or textbox. Valid values: 0-360°, in case of false entry, the value is not accepted.

Select intensity (3)

A different intensity is given in each sequence. Entry is possible via slider or textbox. Valid values: 0-100%, in case of false entry, the value is not accepted.

Select duration (4)

The duration of each sequence is defined by this slider. It should be noted that the duration of all sequences is included in the calculation of the minimum pause time. Entry is possible via slider or textbox. Valid values: 0-2500ms, in case of false entry, the value is not accepted.

Pause time (5)

A pause time, in which the intensity is set to "0". Entry is possible via slider or textbox. Valid values: 0-20000ms, in case of false entry, the value is not accepted. In order to avoid over-heating of the aflex, it should be controlled by a relative switching duration > 15%. If the pause time is too low, a warning and the necessary pause duration are displayed.

Demo Name(6)

Name of the demo under which it is identified

Description (7)

This description is displayed when the demo is selected. A sensible description should be chosen. A maximum of 100 characters is possible.

Export (8)

Export the simulation to a local file. Used to create backups or transfer simulations to other computers.

Import (9)

Import a simulation in the aflexConfigurator. to use this.

Save (10)

Saves the simulation. When changing an existing demo, the user can decide whether to overwrite it with the new values or generate a new demo. In the second case, however, the name should be adapted to facilitate identification. If the name does not adapt, the configuration is saved with the same name and the name supplemented with an index (X).

Cancel (11)

Abort the process without saving and close the window.

4.6 Sub menu controller

The control unit is parametrized in the "controller menu". The TCP/IP connection is configured, the telnet server is activated and backups are saved or imported.

Figure 36: Sub menu controller user "Standard"

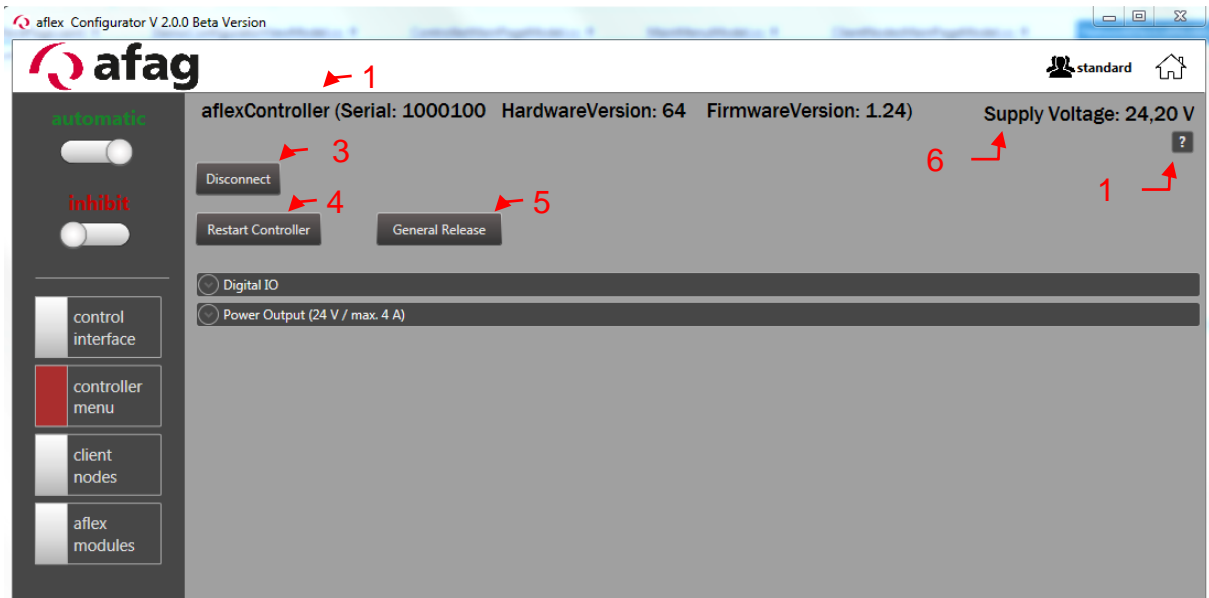
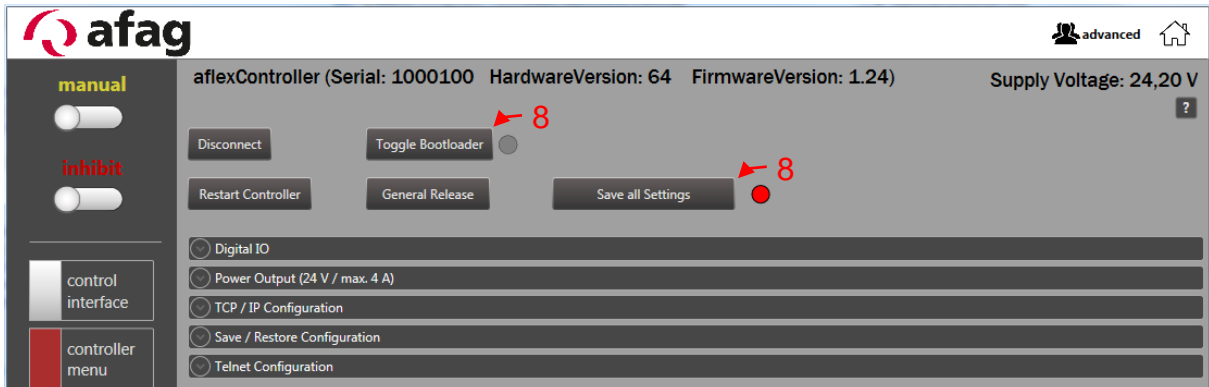

Figure 37: Sub menu controller user "Advanced"



- (1) Display ControlUnit information
- (2) Interrupt connection
- (3) Restart ControlUnit
- (4) Set the general release
- (5) Status display: Operating voltage of the ControlUnit
- (6) Help page
- (7) Activation of the "Bootloader Mode"
- (8) Save

Display ControlUnit information (1)

Displays the device name, the serial number, the hardware version, and the firmware version. This information is required for support requests.

Interrupt connection (2)

Disconnects the connection between aflexConfigurator and control unit. The aflexConfigurator opens the start page.

Restart ControlUnit (3)

This button restarts the control unit. The connection must then be re-established.

General release (4)

The aflex controller requires a general release to switch power outputs. This can be set with a command from the fieldbus interface or the button "General Release" (10). If the release is set to "0", all power outputs are disabled. The background lighting and all aflex actuators are switched off. The current release is indicated by the status (1). If a release exists, this is displayed with "released", otherwise with "inhibit".

Status display: Operating voltage of the ControlUnit (5)

Display the voltage supply of the control unit

Help page(6)

Opens an extract from the manual.

Bootloader Mode (7)

This function is visible from user level "advanced".

The "Bootloader Mode" is used when running software updates on the control unit. If the "Bootloader mode" is active, there is no communication between the control unit and the control modules. The aflex is not functional until the bootloader mode is deactivated.

While the control unit is in the bootloader, the status LED in the control unit housing blinks. The yellow "Connected LED" blinks in the double frequency of the green "Power LED", the "red error LED" is switched off. A connection of the "aflexConfigurator" to the aflex control is not possible. For more information on how to use the bootloader, see the section *Software update ControlUnit*.

Save all Settings (8)

This function is visible from user level "advanced".

To store the current configuration in the permanent (non-volatile) memory of the control unit, use "Save all Settings to EEPROM" (8). Saving can take several seconds. When all data has been saved successfully, the red status display to the right of the button changes to green.

Figure 38: ControlUnit Digital IO & Power Output 24V

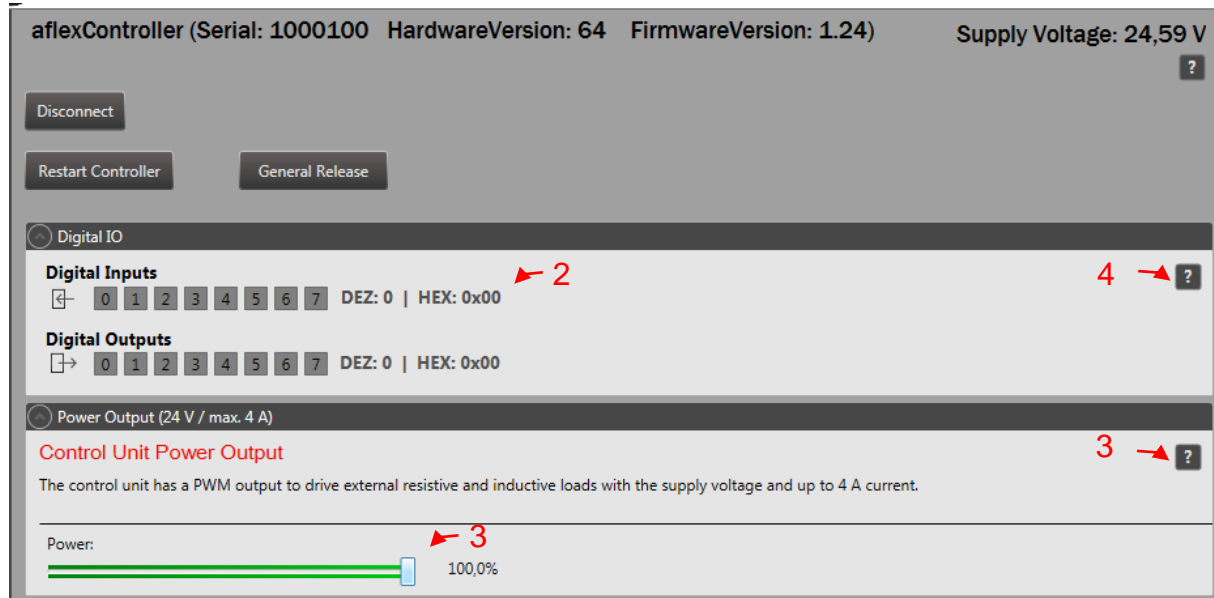

- (1) Status of the digital input/output
- (2) Help page DigitalIO
- (3) Help page PowerOuptut
- (4) 24V PWM Power output

Status of the digital input/output (1)

The digital inputs and outputs are the simplest form of the control and communication of the aflex controller. They are displayed in the expander "Digital IO" and via the LED display in the housing of the control unit (1). They can be freely defined in the "Fieldbus Configuration" menu. The specifications of the digital interface can be found under *Technical data*.

Help page Digital IO (2)

Opens an extract from the operating manual

Help page PowerOuptut (3)

Opens an extract from the manual

Power Output (4)

If there is an aflex 400 lv with integrated Backlight controlled by the ControlUnit, this Output is not used. Otherwise this 24V PWM output is used to control the backlight of the aflex. The pin configuration for the power output is shown in the included circuit diagram. The pulse width is defined by the slider. The specification of the power output can be found at *Technical data*.

Figure 39: TCP / IP Configuration

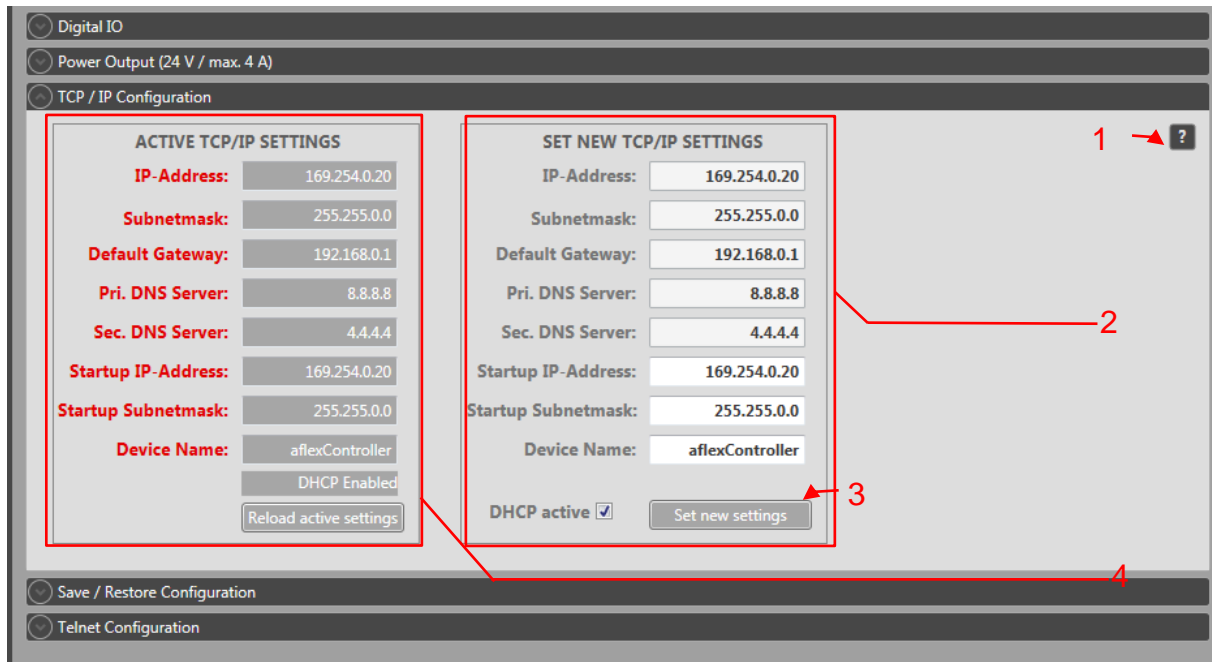

- (1) Help page
- (2) Enter new settings, including the "Device name" of the control unit
- (3) Transfer settings
- (4) Displays the current TCP/IP settings

Help page (1)

Opens an extract from the operating manual

TCP/IP Configuration

This section describes the TCP/IP configuration of the aflex controller. The assigned "device name" is displayed in the "Device List".

New settings are transferred to the control unit with "Set new settings" (3). These are activated after a restart of the control unit. Restart the control unit with the "Restart control unit" button. The connection to the "aflexConfigurator" is interrupted, if necessary the IP address of the computer has to be adjusted.

The current settings can be called up and displayed via the button "Reload active settings" (4).

Figure 40: Save / Restore Controller Configuration

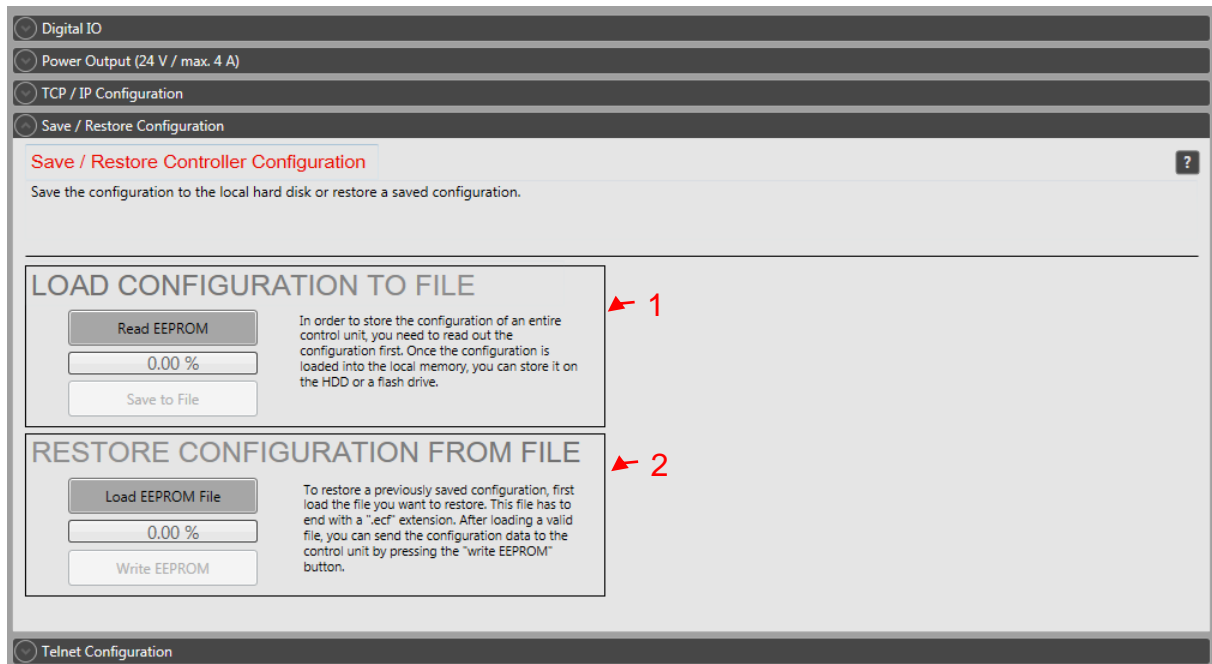

- (1) Create a backup file from all the control data
- (2) Overwrite all control settings from a backup file.

Backup of the control data

All settings are stored on the control unit. To back up these settings you can create a complete backup of the EEPROM. The "Load Configuration to File" area (1) is used to create this backup. After the EEPROM has been read, the backup file will be created using the "Save to File" button. The backup file can be loaded in the "Restore Configuration From File" area (2) and transferred to the EEPROM. To enable this data, the control unit must be restarted.

Figure 41: Telnet Configuration

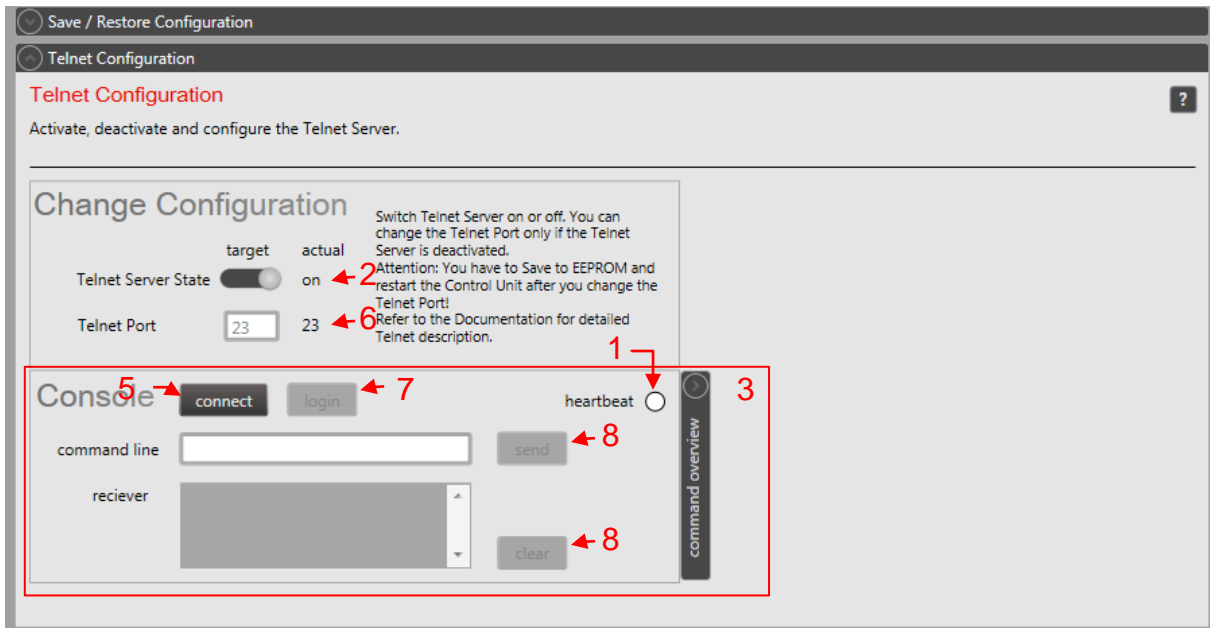

- (1) Activate Telnet-Server
- (2) Telnet Port
- (3) Console for Telnet-Control
- (4) Telnet Heartbeat
- (5) Establish connection
- (6) Login
- (7) Sending the command line
- (8) Delete the receiving messages

Telnet-Server

Each control unit has a telnet server from which the aflex can communicate with a higher-level control. The server is activated in the "aflexConfigurator". More detailed information about the Telnet protocol can be found in the section *Telnet-Server*.

Activate Telnet-Server (1)

Activate the Telnet server

Telnet Port(2)

Port via which the telnet server is addressed

Console for Telnet-Control (3)

The console is used to simulate a superior control and to test the Telnet connection quickly. After the connection and login has been done, it is possible to send commands to the control unit via the "command line".

Telnet Heartbeat (4)

The Telnet Heartbeat is visualized through this display. The blinking LED shows the active Telnet connection. If the LED is not blinking green, no active connection is present.

Establish connection (5)

Connect to Telnet Server

Login(6)

Login with username and password. Further information can be found in the section *Telnet-Server*.

Sending the command line (7)

Sending the "command line". A brief description of the protocol structure is stored in the expander "command overview".

Delete the saving (8)

Delete the receiving buffer

4.7 Sub menu clients

The sub-menu "client nodes" is opened via the main menu. In this, all control modules that communicate with the control unit via the BackSideBus are displayed. Clicking on the individual clients opens the client menu.

Figure 42: Sub menu clients

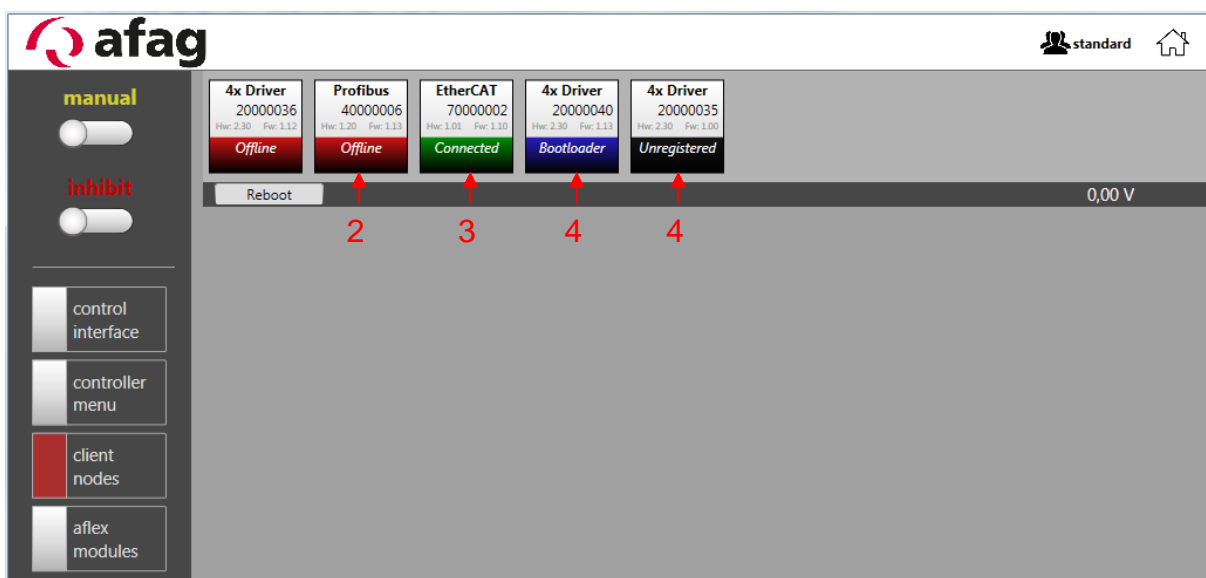

- (1) Offline Client Node
- (2) Client Node connected
- (3) Client Node bootloader active
- (4) unregistered Client Node

Operating modes of the client nodes (1-4)

The different operating modes are shown in colour. Depending on the operating mode, various functions are activated or deactivated.

Offline (1)

If the client's power supply is interrupted or the client is not connected to the control unit via the BackSideBus, this is displayed as "offline".

Connected (2)

The control unit has an existing connection to the client and this can be used with all functions.

Bootloader (3)

The bootloader is used to transfer firmware upgrades to the clients. If the client is in the boot loader, no firmware is active and all client functions are disabled. This notification is also displayed when you click on this client. It is also possible to leave the boot loader directly via the "go back to firmware" button.

Figure 43: Bootloader Mode "Standard" View

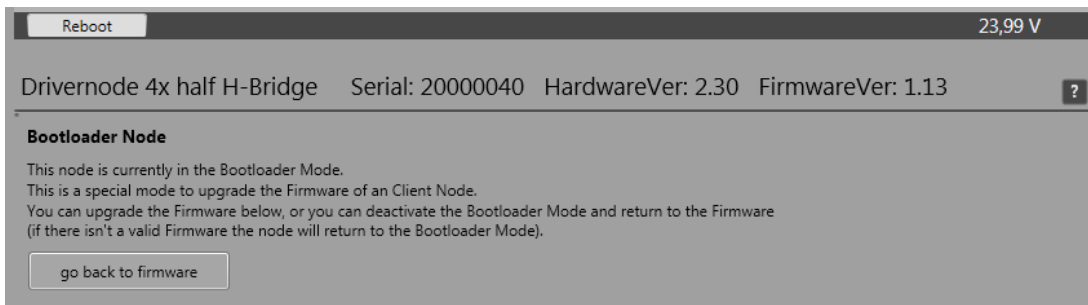
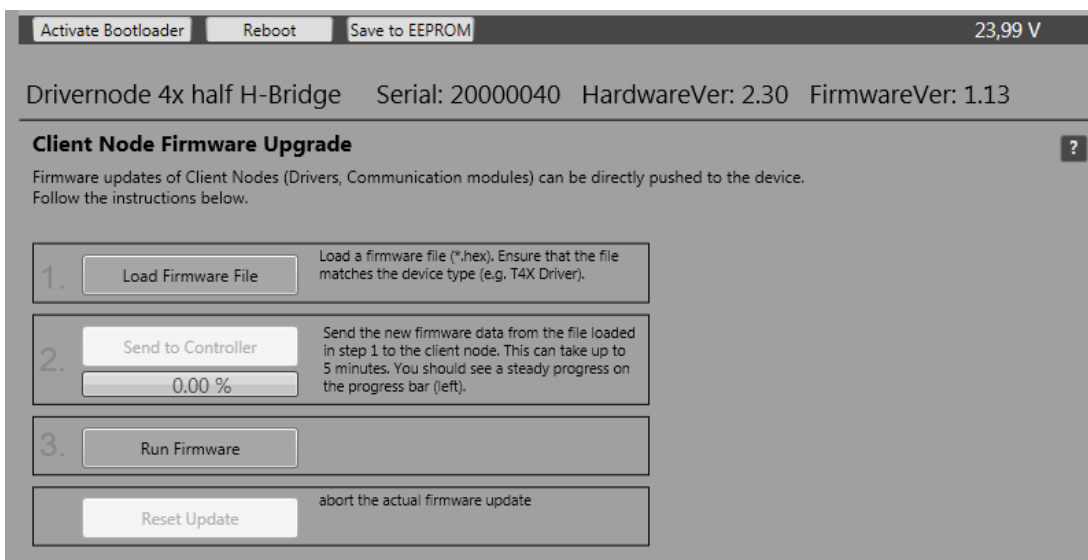

Figure 44: Bootloader Mode "Advanced" View



From the user level "advanced" the firmware update functions are visible. A detailed description of this process can be found in the section 4.10.3.

Unregistered(4)

The client is located on the BackSideBus and a connection to the control unit is possible. However, the client is not registered in the control unit. It is possible to register the client with a mouse click. The client switches to the "connected" or "bootloader" status and the corresponding functions become available. The registration must be saved in order to retrieve you after a restart. The "Save to EEPROM" function is used for this purpose. This is described in the following chapter.

Figure 45: unregistered node



4.7.1 Client Nodes Functions

A client node is selected by a mouse click. The currently selected client node is visualized with a red frame. Depending on the user level, the user has several type-independent functions available. These are described below.

Figure 46: Client Node Functions "Standard" View

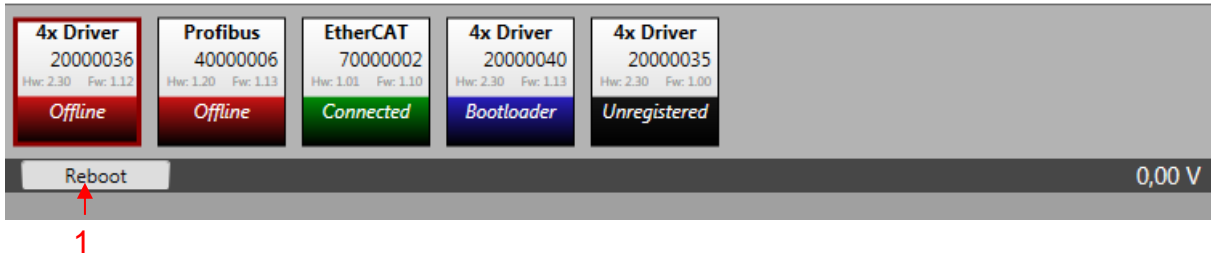

Figure 47: Client Node Functions "Advanced" View

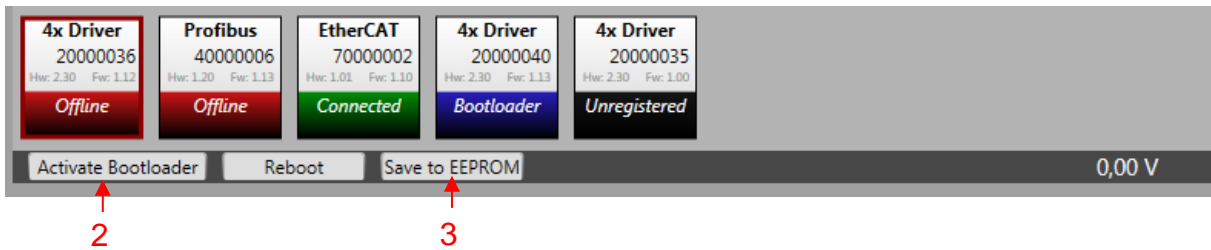
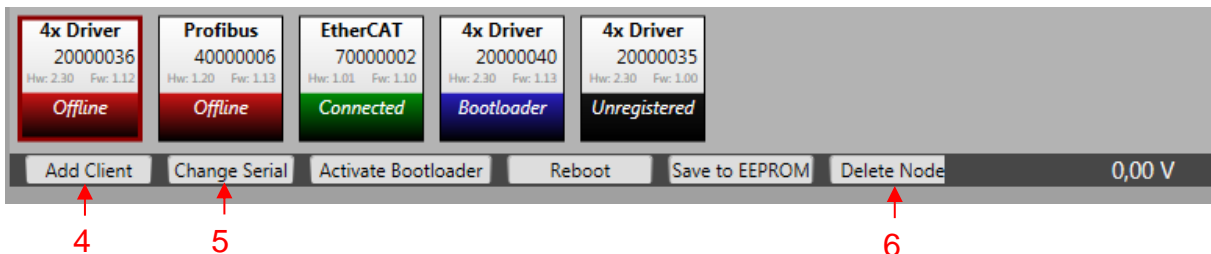

Figure 48: Client Node Functions "Admin" View



- (1) Reboot
- (2) Activate Bootloader
- (3) Save to EEPROM
- (4) Add Client Node
- (5) Change Client Node
- (6) Delete Client Node

Reboot (1)

Restart the client node

Activate Bootloader(2)

This function is available from the user level "advanced". Enables bootloader mode and restarts the client node. When the bootloader is activated, the client node changes to bootloader mode when restarted. In this firmware updates are carried out. More information can be found in the section 4.10.3.

Save to EEPROM(3)

This function is available from the user level "advanced". Saves the settings of the selected client node in the permanent memory.

Add Client Node(3)

This function is available from user level "admin". Adds a new client node. The client node type and the serial number must be entered.

Figure 49: Add Client Node

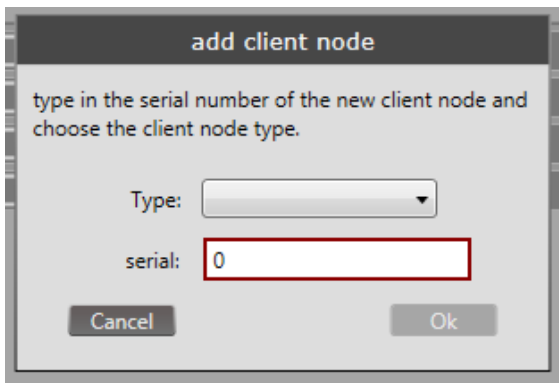

Change Client Node(4)

This function is available from user level "admin" and is used to exchange client nodes. The serial number of the new client node is entered in the text field. All settings of the currently selected client node are transferred to the new one. The current client node is then deleted. If the client node is used in an aflex module, these settings are also accepted.

Figure 50: Exchange Client Node

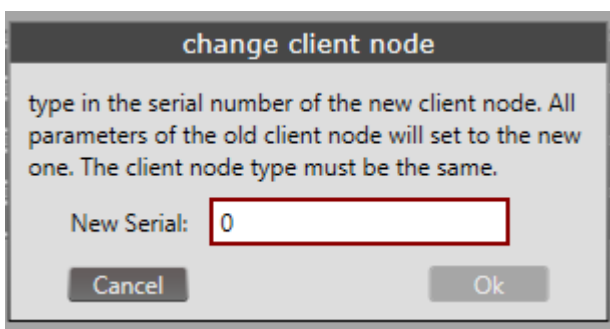

Delete Client Node (5)

Available from user level "admin". Deletes the currently selected client node. Only after saving all parameters via the "controller menu" is this permanently removed from the permanent memory.

4.7.2 T4X Client Node

The T4X module is a driver unit with four power channels. This module is used for controlling the aflex actuators. For a standard aflex with eight actuators, two T4X modules are required. Only "Pulse Mode Continuous" is used to control the aflex actuators. The actuator is controlled by a pulse-modulated signal.

Figure 51: T4X Client Node "Standard" view

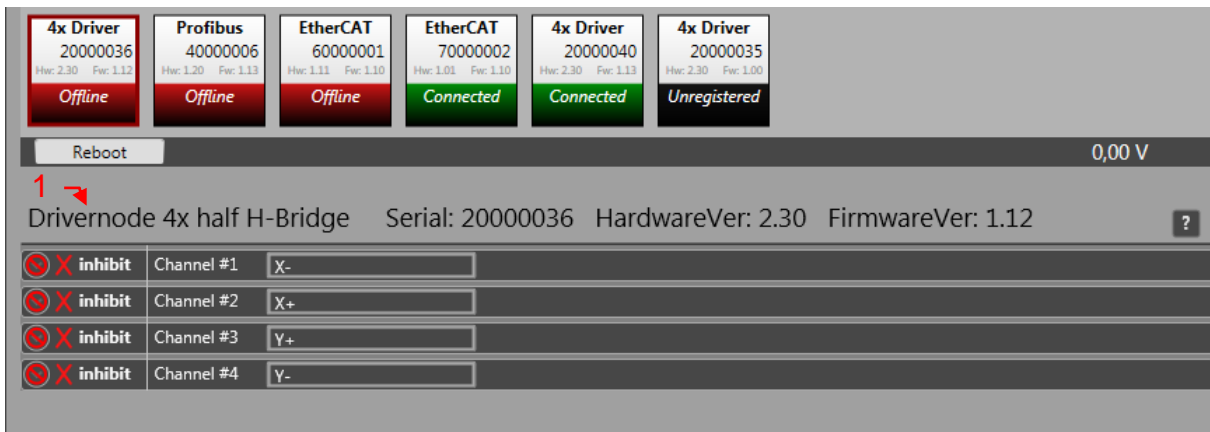

(1) Client Node Information Line

The general information about the client node is displayed in the client node information line (1). The serial number, hardware version and firmware version, this information must be specified for a support request. Under this information the individual channels of the T4X Node are displayed. The user level "standard" has no access rights to it. This is visualized via the prohibition signs.

Figure 52: T4X Client Node "Advanced" view

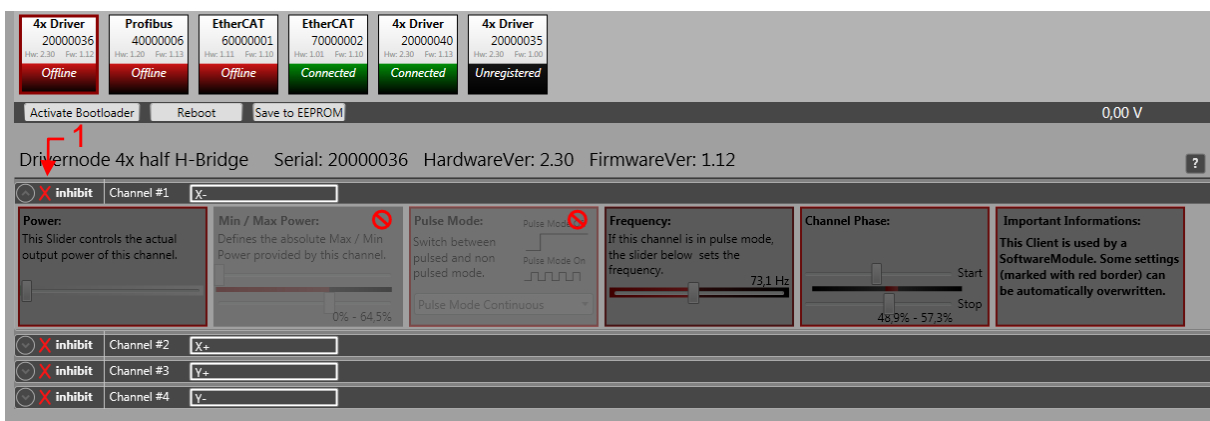

(1) Status Release

From the user level "advanced" the T4X channels will be enabled. All settings exclusive "min/max Power" and "pulse mode" can be adjusted. However, the general release is required to activate the T4X channels. As shown in the figure above, all functions are deactivated and greyed out when the release is missing. The release status of the individual channels is also displayed via the display (1). The general release is set via the toggle button in the "main menu".

Figure 53: T4X Channel Node, general release

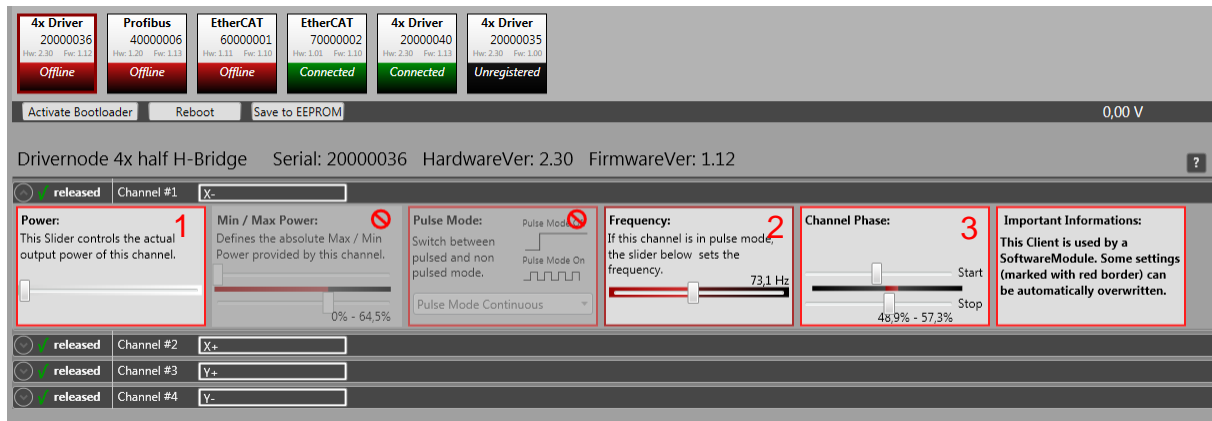

- (1) Power
- (2) Frequency
- (3) Channel Phase

Power (1)

Activate the T4X channel. The power can be adjusted from 0-100%, in this case the duty cycle of the PWM is adjusted.

Frequency(2)

The control frequency of the T4X channel. At this frequency, the PWM output is pulsed.

Channel Phase (3)

The PWM output is not controlled permanently, but pulsed. This pulsing causes the vibration of the aflex system. The pulse duration is set via the phase setting "Channel phase" (3). It defines the period during which the output, with appropriate duty cycle (1), is controlled within a frequency period (2). The maximum channel phase length is 75%.

Figure 54: T4X Channel Node "Admin" view

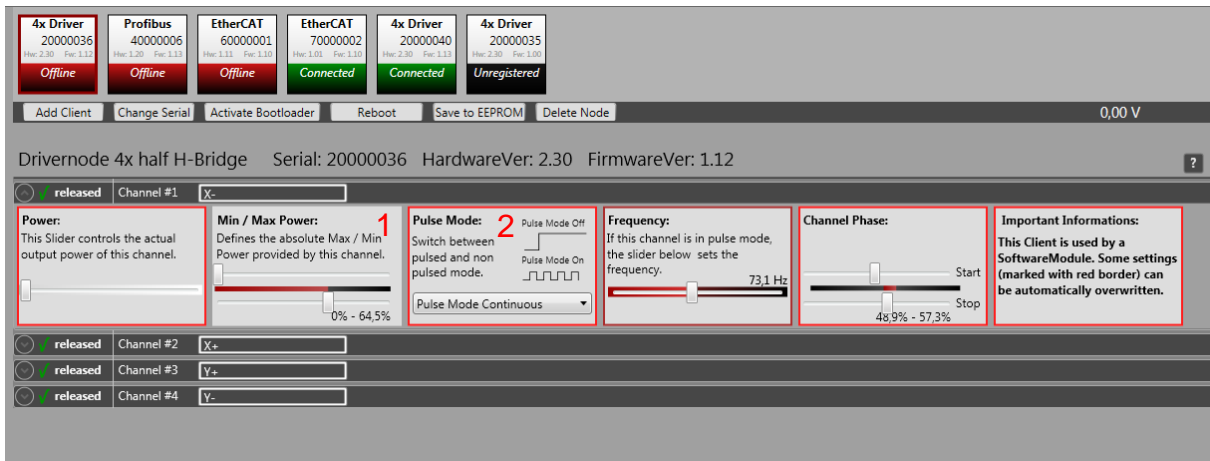

- (1) Min/Max Power
- (2) Pulse Mode

Slider Min/Max Power (1)

The maximum intensity set by this slider, limits the controller intensity of the actuators. The intensity is converted as a percentage to the maximum setting. If this is for e.g. set to 80%, the actuator is only controlled at 80% with a control of 100%.

This function is necessary because the vibration plate is attached to the actuators and is strongly inhibited if the controller power is too high. This is prevented by limiting the maximum controller intensity. To compensate for manufacturing tolerances, this setting can be set individually for each channel.

INSTRUCTION	
	<p>The min/max power of the individual channels is already pre-set in the delivery state and should only be adapted when an aflex exchange is used.</p>

Pulse Mode (2)

An aflex is always controlled with the "Pulse Mode Continuous" during operation. In this mode, each actuator is pulsed with the set frequency and channel phase.

Alternatively, the mode "Pulse Mode Off" can be used to determine the position of an actuator. The actuator is switched over to continuous operation. If the T4X client node is linked to an aflex software module, this setting is automatically overwritten when the aflex is controlled.

INSTRUCTION	
	<p>If an aflex is connected to this channel, the maximum duty cycle of the actuators must be observed. This is specified in the technical data of the aflex.</p>

4.7.3 Backlight Node

The aflex 400 lv is equipped with a back light node. This is the background lighting and is used in the electrical connection test (see Chapter 4.9.1).

Figure 55: *Back light Node*

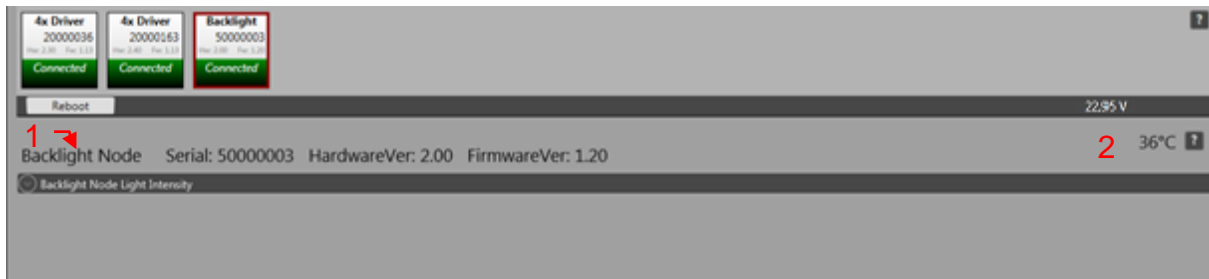

- (1) Client Node Information Line
- (2) Temperature display

The general information about the client node is displayed in the client node information line (1). The serial number, hardware version and firmware version, this information must be specified for a support request.

The temperature display (2) shows the current temperature on the back light board in the aflex.

Figure 56: *Backlit intensity*

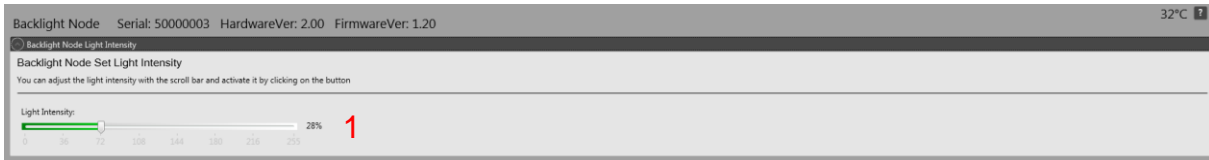

- (1) Set light intensity

The user "standard" has only the possibility to adjust the light intensity of the background lighting.

This light intensity is also controlled via the fieldbus interface.

From the user level "advanced" the back lighting can be parametrized. The background lighting is divided into 48 clusters whose intensity can be set separately. In this way, as homogeneous a background illumination as possible is achieved.

Figure 57: LED Cluster

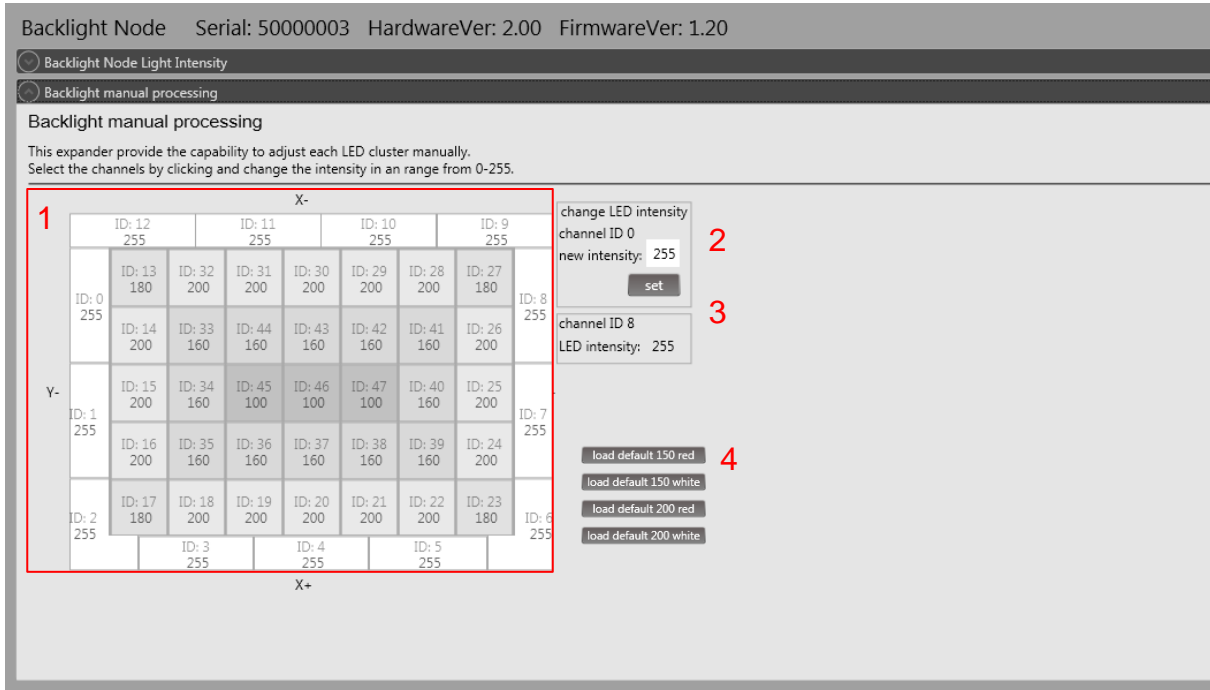

- (1) LED Cluster
- (2) Set LED Intensity
- (3) Current selected channel
- (4) Load default values

LED Cluster (1)

The LED clusters can be defined in their brightness from 0-255. "0" is off, "255" maximum brightness. The clusters are pre-set and calibrated in the delivery state. This setting is not for the brightness setting, which is set in the expander "Backlit Node light Intensity". The calibration should only be adjusted if necessary in case of inhomogeneous tapping surface.

Set LED Intensity (2)

Enter the new intensity of the channel in the text box. The new value is transferred with the "set" button. To save changes permanently, they must be saved using the function "save to EEPROM".

Currently selected channel (3)

Displays the current brightness of the selected channel. The clusters are selected by mouse click.

Load default values (4)

Loading the "factory settings" of the respective backlight type.

4.7.4 Profibus Module

The control module "Profibus module" is used to integrate the aflex control into a Profibus system. This module is optional and is only required in connection with the Profibus.

Figure 58: Profibusmodule "standard" view

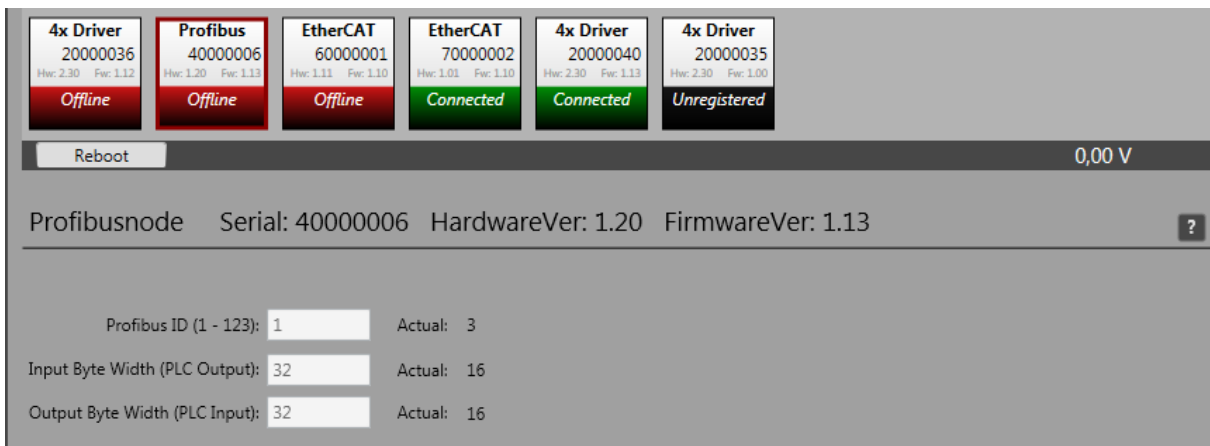
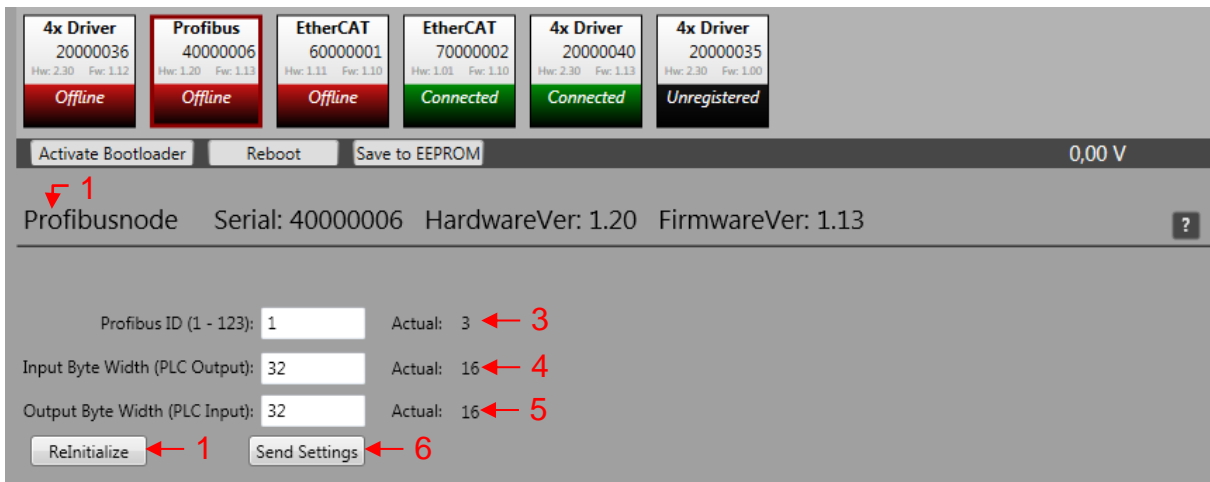

Figure 59: Profibusmodul "advanced" view



- (1) Client Node Information Line
- (2) Profibus Address
- (3) Data width of the fieldbus inputs
- (4) Data width of the fieldbus outputs
- (5) Transfer new settings
- (6) Re-initialize Profibus Node

The Profibus address (2) and the data width of the fieldbus node are defined in the client configuration (3)(4). The settings can be adjusted from the user level "advanced".

The settings are transmitted by means of the "send settings" (5) button. The "reinitialize" button (6) initializes the Profibus module. The data that is to be exchanged via the fieldbus must be configured in the "fieldbus menu". You can find information on this in the section 4.8.

4.7.5 EtherCAT Module

INSTRUCTION



The control unit must have at least firmware version v1.32 in order to use the EtherCAT Client Node.

The control module "EtherCAT" is used to integrate the aflex control into an EtherCAT system. This module is optional.

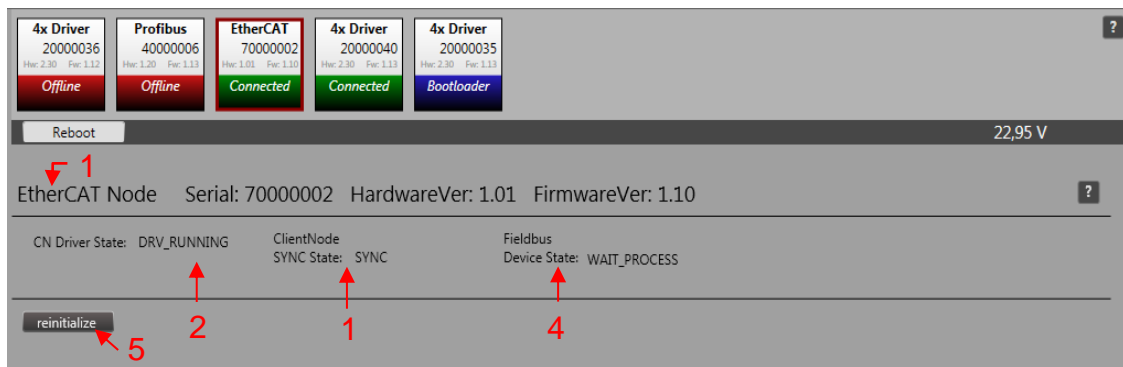

- (1) Client Node Information Line
- (2) Client Node Driver State
- (3) Client Node Sync State
- (4) Fieldbus Device State
- (5) Reinitialize Client Node

Client Node Informations Line (1)

General information about the client node is shown. The serial number, hardware version and firmware version, this information must be specified for a support request.

Client Node Driver State (2)

Status of the EtherCAT driver in the client node.

DRV_RUNNING	Driver active, normal operating condition
STOP	Drivers stopped. Restart via "reboot" or "reinitialize" possible.

Client Node Sync State(3)

The fieldbus configuration between EtherCAT Node and control unit is synchronized. This check takes place at every restart, reinitialization process or changes to the fieldbus configuration.

SYNC	Test completed successfully, normal operating condition
ERROR_MAX_RETRY	Check failed. Maximum attempts exceeded. Check configuration. ClientNode restart.

Fieldbus Device State(4)

Status display of the fieldbus connection

WAIT_PROCESS	Client Node is connected to the network
PROCESS_ACTIVE	There is a connection to the PLC, the data exchange is active
IDLE	PLC is in STOP mode
ERROR	Network errors (e.g., cable break)

Reinitialize Client Node(5)

Reinitialize the client node.

4.7.6 Profinet Modul

INSTRUCTION	
	<p>The control unit must have at least firmware version v1.32 in order to use the Profinet Client Node..</p>

The control module "Profinet" is used to integrate the aflex control into an Profinet system. This module is optional.

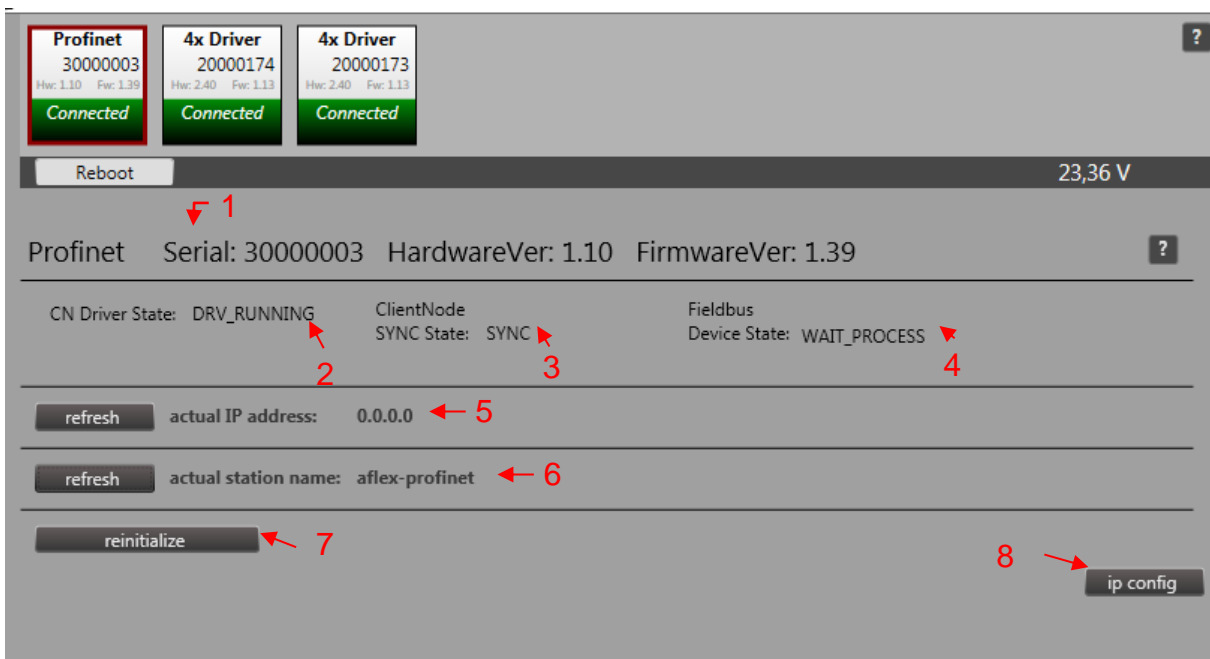

The screenshot shows a control interface for the Profinet module. At the top, there are three status cards: 'Profinet' (Serial: 30000003, Hw: 1.10, Fw: 1.39, Connected), and two '4x Driver' cards (Serials: 20000174 and 20000173, Hw: 2.40, Fw: 1.13, Connected). Below these is a 'Reboot' button and a voltage display '23,36 V'. The main section is titled 'Profinet' and shows 'Serial: 30000003', 'HardwareVer: 1.10', and 'FirmwareVer: 1.39'. It contains three status lines: 'CN Driver State: DRV_RUNNING' (2), 'ClientNode SYNC State: SYNC' (3), and 'Fieldbus Device State: WAIT_PROCESS' (4). Below these are 'refresh' buttons for 'actual IP address: 0.0.0.0' (5) and 'actual station name: aflex-profinet' (6). At the bottom, there is a 'reinitialize' button (7) and an 'ip config' button (8).

- (1) Client Node Information Line
- (2) Client Node Driver State
- (3) Client Node Sync State
- (4) Fieldbus Device State
- (5) actual IP address
- (6) actual station name
- (7) Reinitialize Client Node
- (8) Tool IPconfig

Client Node Informations Line (1)

General information about the client node is shown. The serial number, hardware version and firmware version, this information must be specified for a support request.

Client Node Driver State (2)

Status of the Profinet driver in the client node.

DRV_RUNNING	Driver active, normal operating condition
STOP	Drivers stopped. Restart via "reboot" or "reinitialize" possible.

Client Node Sync State(3)

The fieldbus configuration between Profinet Node and control unit is synchronized. This check takes place at every restart, reinitialization process or changes to the fieldbus configuration.

SYNC	Test completed successfully, normal operating condition
ERROR_MAX_RETRY	Check failed. Maximum attempts exceeded. Check configuration. ClientNode restart.

Fieldbus Device State(4)

Status display of the fieldbus connection

WAIT_PROCESS	Client Node is connected to the network
PROCESS_ACTIVE	There is a connection to the PLC, the data exchange is active
IDLE	PLC is in STOP mode
ERROR	Network errors (e.g., cable break)

Actual IP address (5)

Shows the actual IP address of the Profinet Modul. Is only actualized by clicking the button "refresh". You can't set the IP address from the aflexConfigurator, but you can use the Tool IP Config to do this.

Actual station name (6)

Shows the actual station Name of the Profinet Modul. Is only actualized by clicking the button „refresh“. After clicking the button there can be a delay of 1-2 seconds until the name is actualized. You can't set the station name from the aflex Configurator.

reinitialize Client Node(7)

Reinitialize the client node. After changing the Fieldbus configurator this function must executed.

INSTRUCTION	
	<p>The delivered device description file is only valid when using the standard "Profinet_Config". Otherwise the Profinet device won't recognized.</p>

IPConfig(8)

Starts the external tool "IPConfig".

This tool is used to adjust the IP Configuration of the Profinet Modul. The Tool is always on top. The configuration made by the PLC will be overwritten.

INSTRUCITON	
	The Tool "IPConfig" communicates with the Profinet interface by the Ports X2/X3 of the Profinet Modul. There must be a corresponding Ethernet connection between the PC and these Ports.

Behavior of the outputs if IOPS = Bad:

- State changes to IDLE. The network is informed that the I/O data of the sub-module with IOPS = BAD is substituted with zeros (clear).

Behavior of the outputs if connection is aborted:

- State change to WAIT_PROCESS. The network is informed that the I/O data of all sub modules is substituted with zeros (clear).

Behavior of the outputs at power on:

- The network is informed that the I/O data of all sub modules is substituted with zeros (clear).

Behavior if reset to factory defaults:

- The communication parameter, like station name and ip address being reset. The In-/Output configuration of the Device are not changed.

4.7.7 EtherNet/IP Modul

INSTRUCTION	
	<p>The control unit must have at least firmware version v1.32 in order to use the EtherNet/IP Client Node..</p>

The control module "EtherNet/IP" is used to integrate the aflex control into an EtherNet/IP system. This module is optional.

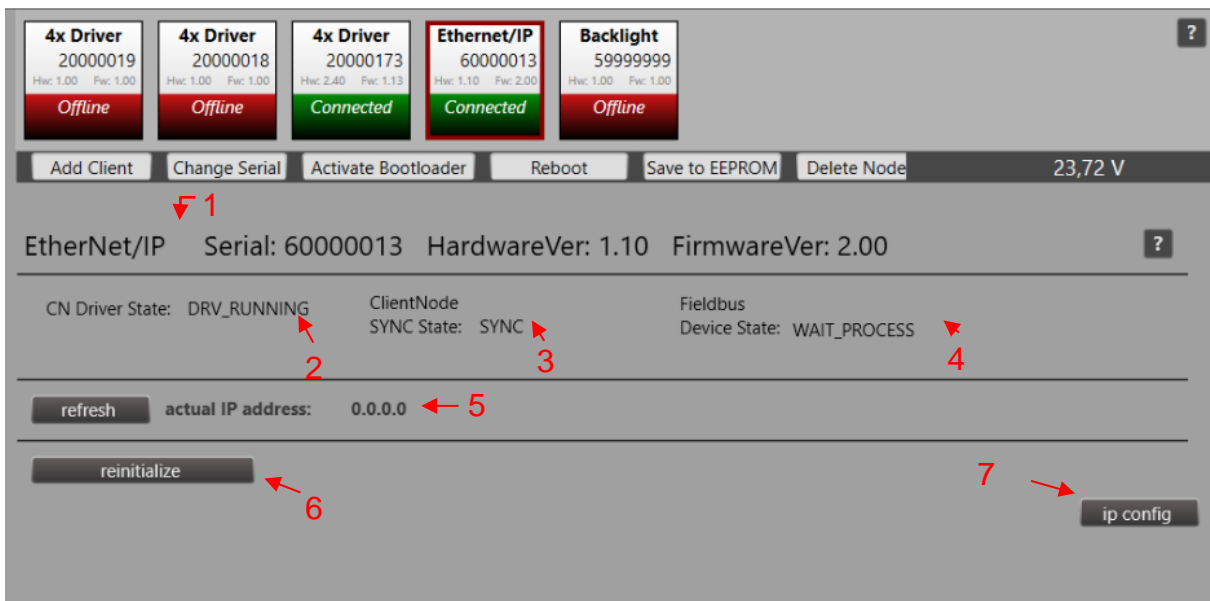

- (1) Client Node Information Line
- (2) Client Node Driver State
- (3) Client Node Sync State
- (4) Fieldbus Device State
- (5) actual IP address
- (6) Reinitialize Client Node
- (7) Tool IPconfig

Client Node Informations Line (1)

General information about the client node is shown. The serial number, hardware version and firmware version, this information must be specified for a support request.

Client Node Driver State (2)

Status of the EtherNet/IP driver in the client node.

DRV_RUNNING	Driver active, normal operating condition
STOP	Drivers stopped. Restart via "reboot" or "reinitialize" possible.

Client Node Sync State(3)

The fieldbus configuration between Client Node and control unit is synchronized. This check takes place at every restart, reinitialization process or changes to the fieldbus configuration.

SYNC	Test completed successfully, normal operating condition
ERROR_MAX_RETRY	Check failed. Maximum attempts exceeded. Check configuration. ClientNode restart.

Fieldbus Device State(4)

Status display of the fieldbus connection

WAIT_PROCESS	Client Node is connected to the network
PROCESS_ACTIVE	There is a connection to the PLC, the data exchange is active
IDLE	PLC is in STOP mode
ERROR	Network errors (e.g., cable break)

Actual IP address (5)

Shows the actual IP address of the EtherNet/IP Modul. Is only actualized by clicking the button “refresh”. You can’t set the IP address from the aflexConfigurator, but you can use the Tool IP Config to do this.

reinitialize Client Node(6)

Reinitialize the client node. After changing the Fieldbus configurator this function must executed.

INSTRUCTION	
	<p>The delivered device description file is only valid when using the standard “EtherNet/IP_Config”. Otherwise the EtherNet/IP device won’t recognized.</p>

IPConfig(7)

Starts the external tool "IPConfig".

This tool is used to adjust the IP Configuration of the EtherNet/IP Modul. The Tool is always on top. The configuration made by the PLC will be overwritten.

INSTRUCITON	
	<p>The Tool "IPConfig" communicates with the EtherNet/IP Client Node by the Ports X2/X3. There must be a corresponding Ethernet connection between the PC and these Ports.</p>

LED description

LED	color	Description	comment
err	red	error	ON = internal error occurred, voltage must be interrupted to resume operation
con	yellow	connected	Flickering = normal operation. Display of the connection to the ControlUnit via the BackSideBus.
pwr	green	power	ON = Power supply OK.
fb_data	yellow	Fieldbus data	display of the input/output data. flashing = data exchange active
nw state	green/red	Network State	See table "LED Network State"
X2con /X3con	green	X2 / X3 Link	See table LED X2/X3 connection

table LED Network State

Nwstate LED	Description	comment
Off	offline	No IP address assigned
green	online	Online, at least one connection established
green, flashing	no connection	Online, no connection established
red	Internal error	Duplicate IP address or Unexpected Internal Error
red, flashing	Timeout error	Connection timeout

table X2/X3 Connection

X2 / X3 LED	description	comment
Off	No Link	X2/X3 not connected. No communication
green	Link	Ethernet connected, but no communication
green, flickering	activity	Ethernet connected, communication active

4.7.8 Webserver Profinet & EtherNet/IP

The Profinet and the EtherNet/IP modul provides a webserver. To open it there must be an established TCP/IP connection to one of the Modul ports.

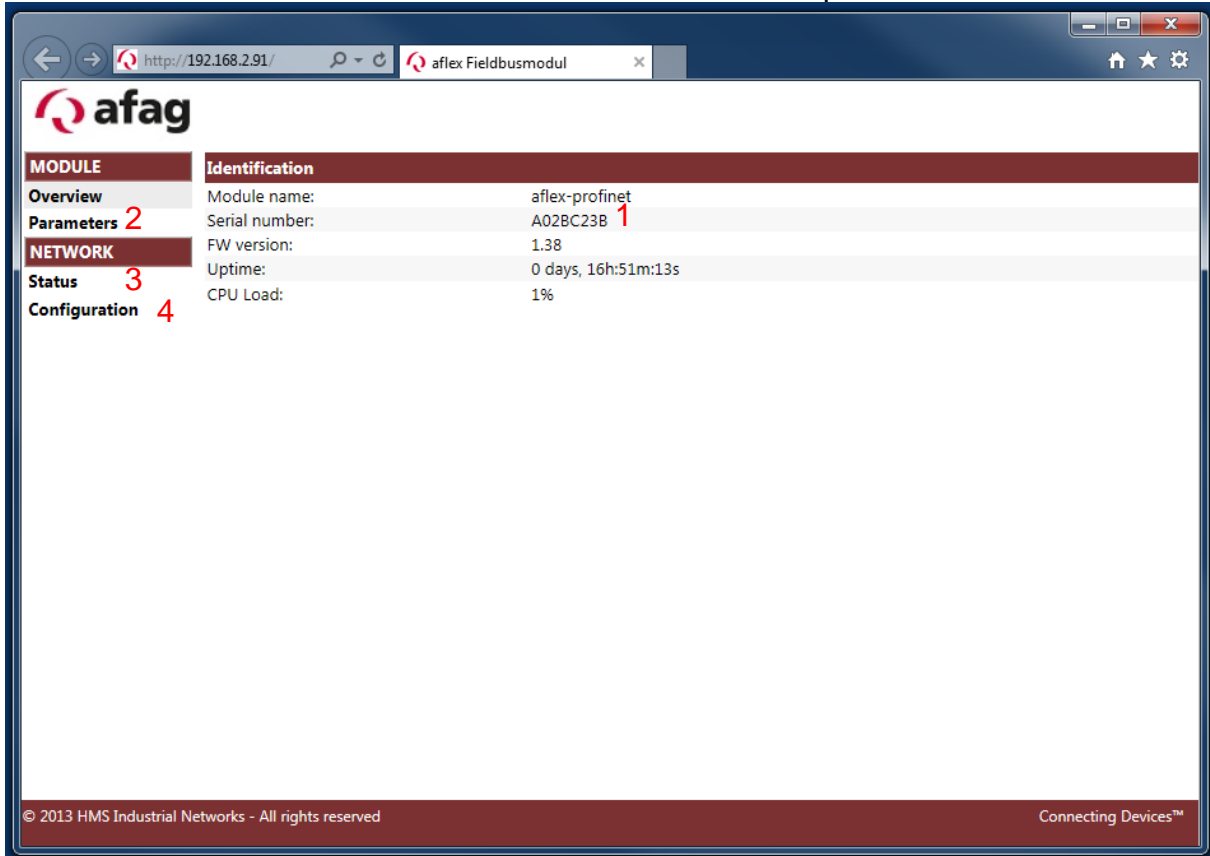

- (1) Serial number
- (2) Menu Parameters
- (3) Menu Status
- (4) Menu Configuration

Serial number(1)

The serial number is hexadecimal coded.

Menu Parameters(2)

Shows the actual aflex values.

Menu Status(3)

Shows the actual IP configuration

Menu Configuration(4)

Changes the IP configuration. This settings may be overwritten automatically by a connected PLC:

In the menu “parameters” the actual parameters are shown.

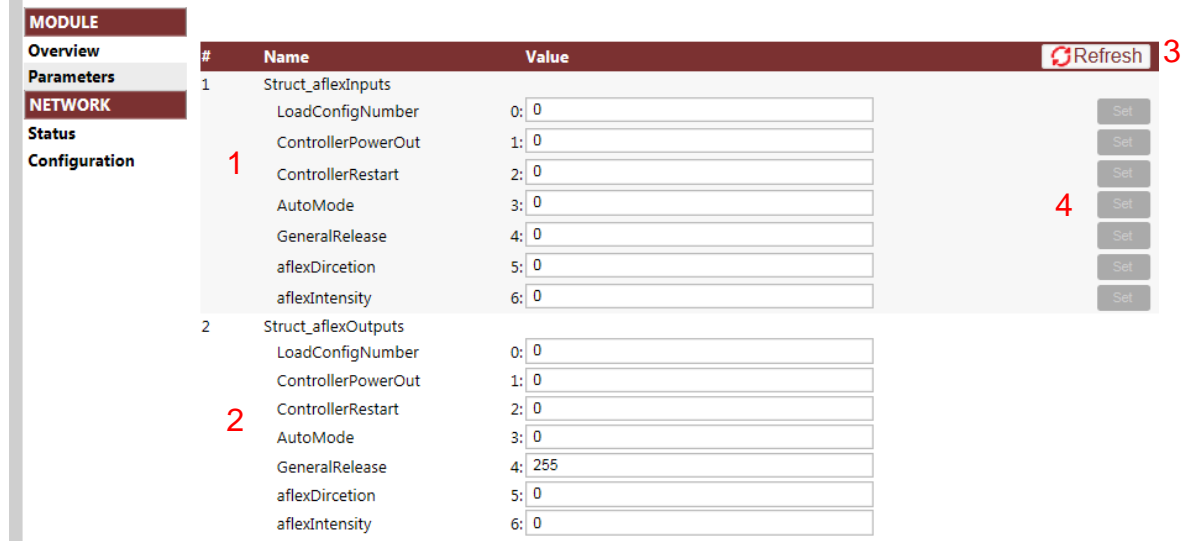

#	Name	Value
1	Struct_aflexInputs	
	LoadConfigNumber	0: 0
	ControllerPowerOut	1: 0
	ControllerRestart	2: 0
	AutoMode	3: 0
	GeneralRelease	4: 0
	aflexDirction	5: 0
aflexIntensity	6: 0	
2	Struct_aflexOutputs	
	LoadConfigNumber	0: 0
	ControllerPowerOut	1: 0
	ControllerRestart	2: 0
	AutoMode	3: 0
	GeneralRelease	4: 255
	aflexDirction	5: 0
aflexIntensity	6: 0	

- (1) aflex Inputs
- (2) aflex Outputs
- (3) Refresh
- (4) Set Input

aflex Inputs(1):

From the superior PLC to the aflex.

aflex Outputs(2):

From the aflex to the superior PLC.

Ausgänge des aflex aus Sicht des aflex. Vom aflex in die Übergeordnete Steuerung.

Refresh (3):

Values only actualized by clicking this button.

Set Input (4):

It's not allowed to set the Inputs from the webserver. Following error message occurs when using this function.

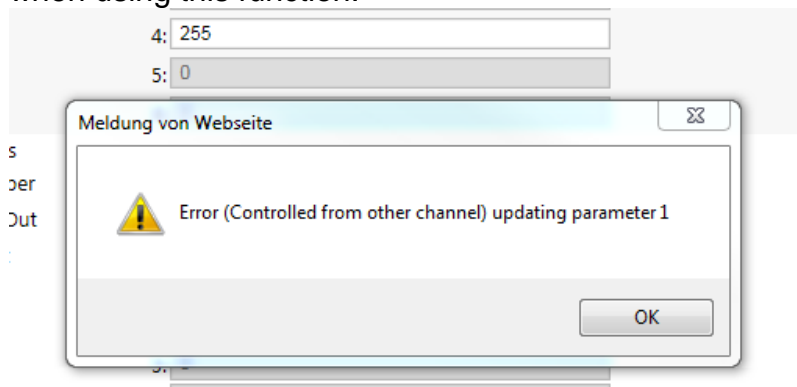

4.8 Sub menu Fieldbus configuration

This menu is visible from the user level "advanced".

The aflex is addressed by the higher-level controller via the fieldbus interface. The control unit provides eight digital inputs/outputs as well as a Telnet server. In addition, fieldbus modules, e.g. the Profibus module, can be integrated into the control system. Each control module (e.g., T4X driver or control unit) and each aflex have multiple controllable parameters. In the fieldbus configuration, these parameters are defined in the fieldbus.

Further information on the commands and control of the aflex can be found in chapter 5.6 Integration with the higher-level control system.

Figure 60: Sub menu Fieldbus configuration

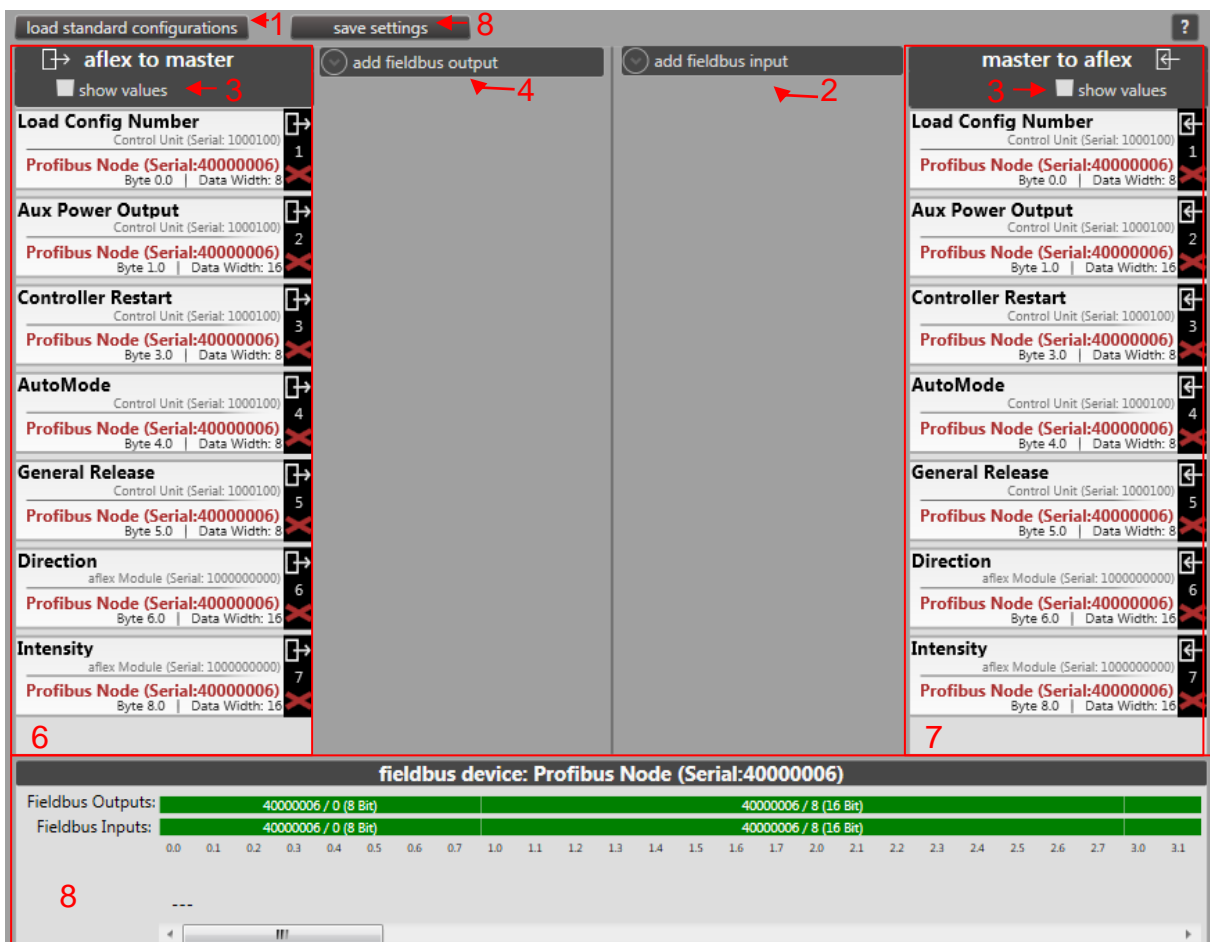

- (1) Load a configuration
- (2) Save the fieldbus settings
- (3) Display value of the fieldbus input and output
- (4) Add fieldbus output
- (5) Add fieldbus input
- (6) Overview of the fieldbus output
- (7) Overview of the fieldbus input

(8) Display the fieldbus configuration

Loading a configuration(1)

This function provides different standard configurations. If a “Profinet”, “EtherNet/IP” or “EtherCAT” interface is used, then the use of the relevant default configuration is imperative. They include all parameters that are required for a complete aflex actuation. We urgently recommend using these configurations. Clicking on the button opens the window illustrated below. Where configured accordingly, the product and interfaces selection is chosen in the combination boxes.

Figure 61: Loading a fieldbus configuration

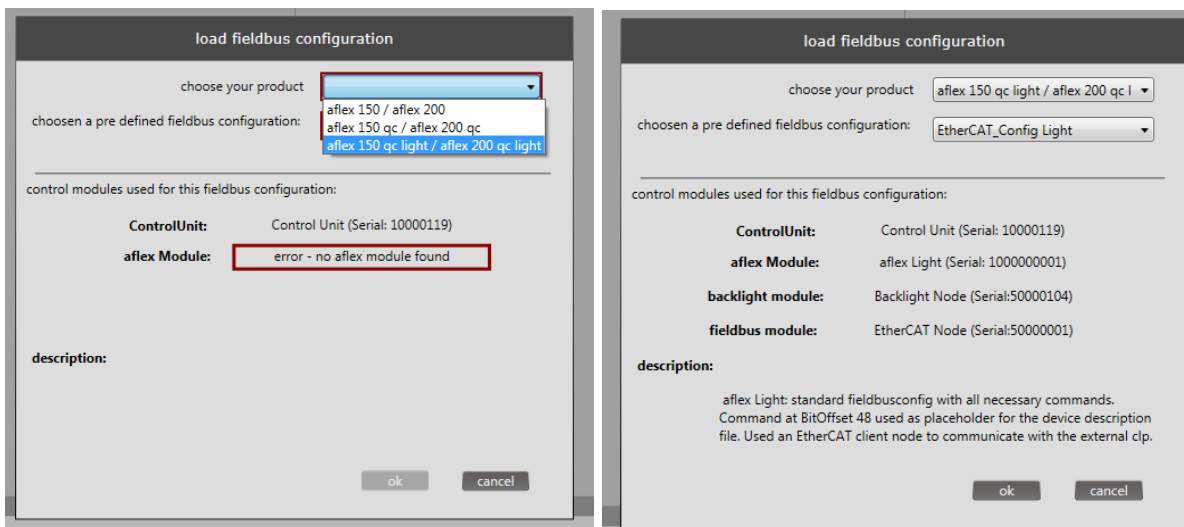

Save the fieldbus settings (2)

Saves the current fieldbus settings.

Display value of the fieldbus input and output (3)

When the checkbox is activated, the values of the fieldbus inputs and outputs are displayed. These must be updated via the "refresh" button. The checkbox for the display and the button "refresh" activate or update both the inputs and the outputs. The values of the fieldbus interface are shown. No current values are displayed. The values are displayed decimal and hexadecimal coded.

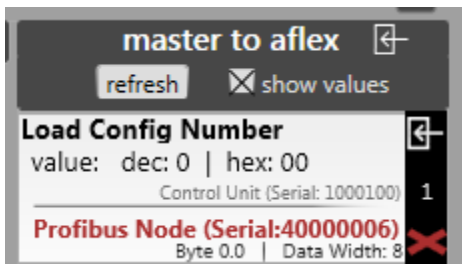

Add fieldbus output (4)

Add fieldbus output. With EtherCAT, EtherNet/IP or Profinet fieldbus interfaces no output can be added manually. The "standard configuration" must be used.

Add fieldbus input (5)

Add fieldbus input. With EtherCAT, EtherNet/IP or Profinet fieldbus interfaces no input can be added manually. The "standard configuration" must be used.

Overview of the fieldbus output (6)

Display the fieldbus output (6)

Overview of the fieldbus input (7)

Display the fieldbus input.

Display the fieldbus configuration (8)

Display the fieldbus configuration.

Figure 62: Structure of the inputs/outputs

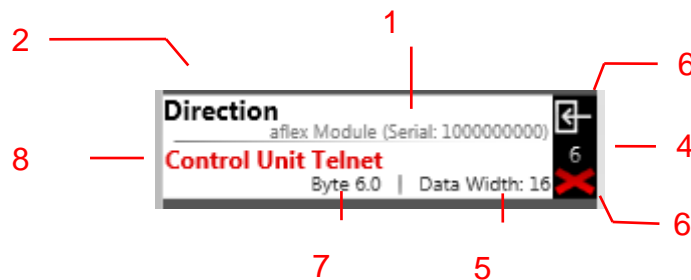

- (1) Fieldbus interface
- (2) Command identification addressed parameters
- (3) Addressed control module whose parameter is controlled
- (4) Symbol for fieldbus input
- (5) Identification number of the fieldbus input
- (6) Delete the fieldbus input
- (7) Data range of the fieldbus input
- (8) Byte offset of the fieldbus input

Fieldbus interface/Fieldbus Device (1)

The fieldbus interface defines the interface via which the higher-level control is communicated.

Parameter/Target Field (2)

Defines which parameter is described via the fieldbus input.

Addressed control module / Target device (3)

Defines the control module/software module whose parameter is changed. In this example, the "direction" of the aflex software module is changed with the serial number 1000000000.

Data range of the fieldbus input (7)

The data range of the parameters are variable and can thus be adapted to the fieldbus. The selected data range is internally converted into the original data range, which is displayed in brackets when selected. If a parameter with the native data range of 32 bit is defined as 16 bit further input, it corresponds to 100% (32 bit = 4294967295 dec.) 65535 decimal is given.

Byte Offset of the Fieldbus Inputs (8)

The byte offset defines the position at which the parameter is located in the fieldbus.

4.8.1 "Direction" command for aflex lv products

Because the aflex lv does not support conveying components, the "Direction" command is not available. However, because this is linked for interfaces such as Profinet, EtherNet/IP or EtherCAT, in this case, the "Direction" command shows the addition "not available".

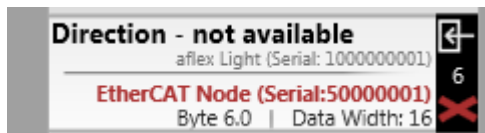

4.9 Sub menu aflex module

The aflex is parametrized in this menu. The aflex is displayed in the control unit. The driver outputs of the T4X client nodes are linked to their actuators. If the aflex is controlled, the control unit recognizes which driver outputs are to be controlled and controls the client nodes accordingly. The correct driver assignment is a basic prerequisite for the aflex function.

Figure 63: Sub menu software module "

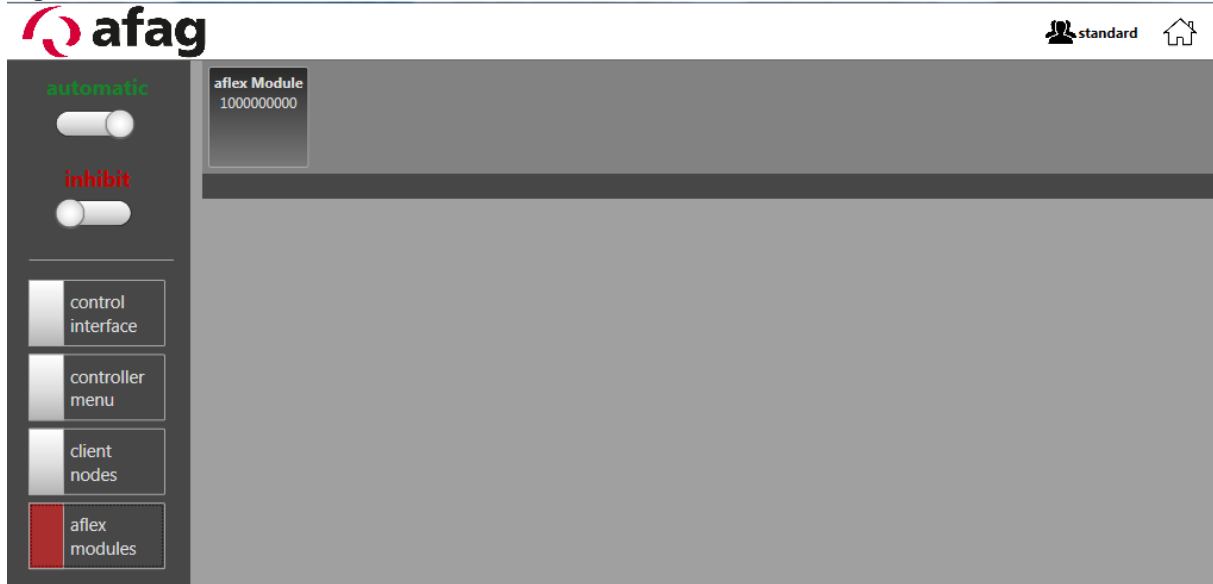

Standard" view

Figure 64: aflex Module "standard" view

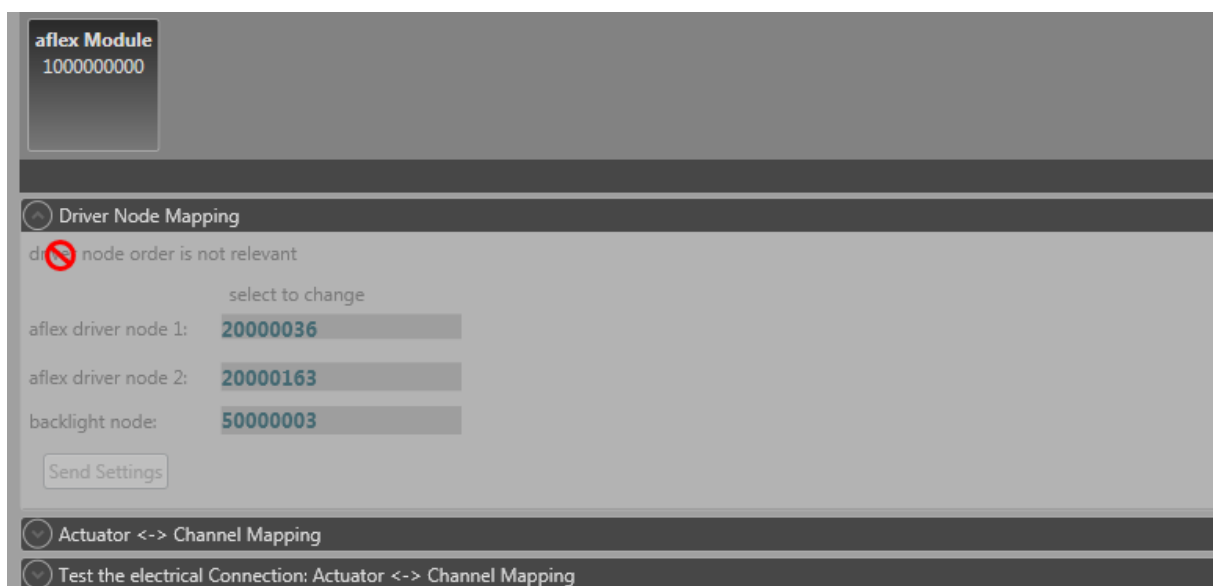

The user "standard" has no rights in the aflex menu. Only the current settings are displayed, they can not be changed. The driver assignment can be changed only from the user level "admin".

Figure 65: aflex Module "admin" view

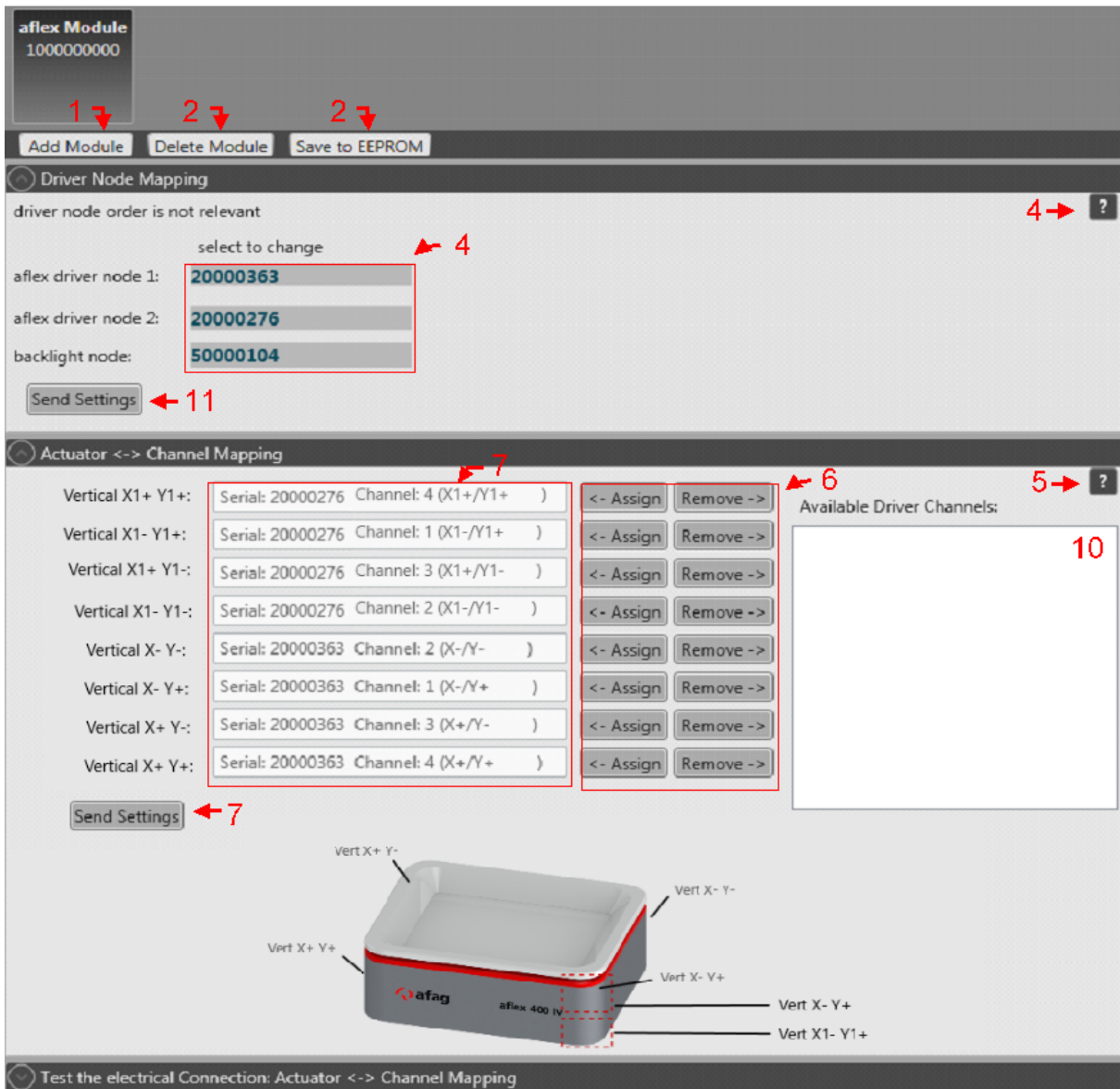

- (1) Add an aflex module
- (2) Delete the aflex module
- (3) Save the aflex module
- (4) Select the used client nodes
- (5) Help page
- (6) Transfer the selection to the control unit
- (7) Display of the assigned channels
- (8) Assign channel / disconnect
- (9) Help page
- (10) Unassigned channels
- (11) Transfer the assignments to the control unit

Add an aflex module (1)

This function is available from user level "admin". Adds a new aflex module Here you can choose between aflex qc, aflex lv and aflex qc light. Depending on the product, make sure you make the appropriate choice.

Delete the aflex module (2)

This function is available from user level "admin". Deletes the currently selected aflex module

Save the aflex module (3)

This function is available from user level "advanced". Saves the setting of the aflex module.

Select the used client nodes (4)

This function is available from user level "Admin". The necessary client nodes are assigned to the aflex software module. If no client is assigned, "0" is displayed. A serial number is displayed for an already assigned driver. By clicking on the display ("0" or respective serial number), the option for assigning the clients opens.

Help page(5)

Opens an extract from the manual.

Transfer the selection to the control unit (6)

This function is available from user level "admin". Transfers the selected client nodes to the control unit. Caution: These are stored in the permanent memory only after saving ("Save to EEPROM" / "save all").

Display of the assigned channels (7)

The individual driver channels are assigned to the aflex actuators, which is also referred to as mapping.

INSTRUCTION	
	<p>The mapping and electrical wiring must match. The mapping is preconfigured in the delivery state and the electrical wiring should therefore be carried out according to the instructions. The drivers for vertical and horizontal actuators must not be interchanged.</p>

Assign channel/Delete connection (8)

This function is available from user level "Admin". The button "remove" triggers a current link of the button "assign" establishes a link with the selected channel.

Help page (9)

Opens an extract from the manual.

Unassigned channels (10)

The available channels not assigned yet. For the proper function of the aflex, all driver channels must be assigned and must match the electrical wiring.

Transfer the assignment to the ControlUnit (11)

Transmits all current assignments to the control unit. These settings must be transferred to the non-volatile memory using the "Save to EEPROM" function or the "save all" function in the control unit menu.

4.9.1 Test electrical Connection

This function allows you to check the wiring of driver modules to the aflex to the set mapping. The test automatically controls each actuator one at a time. The corresponding control signal is checked via the integrated back light board in aflex. If wires are interchanged or open, this is detected.

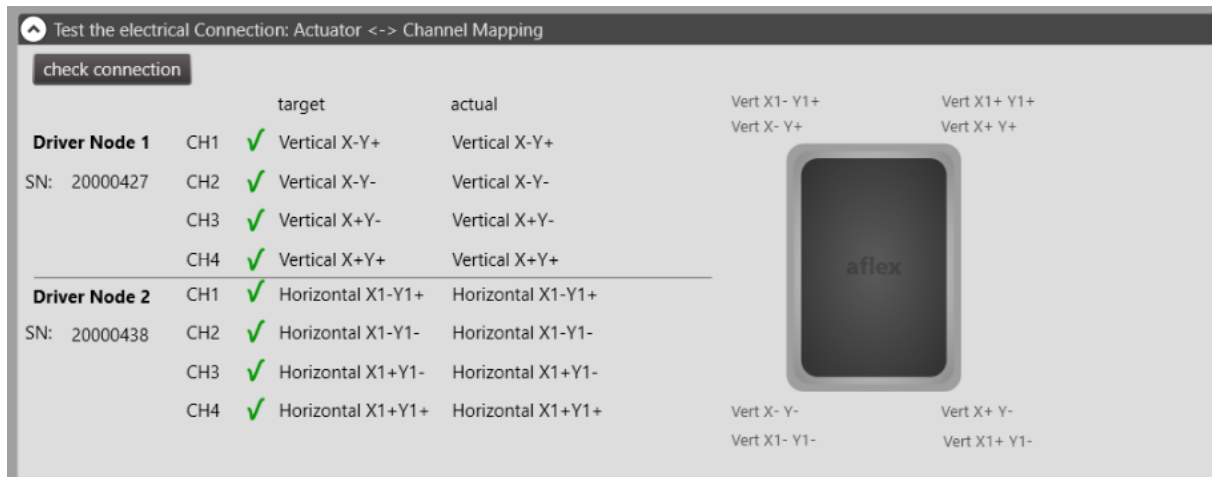

Error Outputs of the test:

Status	Description
Red Cross & Channel Name	Actual target do not match, check wiring.
Not Tested	No test has been carried out since the Software start
CH (+) wire connection fault	The control signal does not come in the aflex. The channel + wire is open
Interchanged or CH(-) fault	The wires of the channel are interchanged or the channel wire is open
clientNode connection fault	An aflex Linked ClientNode is offline or not available.
General Release is missing	General release must be set to perform the test
Fault ClientNode mapping	No driver ClientNodes have been added to the aflex software module. ClientNode and Channel Mapping.
Not Assigned	The aflex channel has not yet been linked to a driver channel. Carry out channel mapping

4.10 Software update

All control modules can be provided via the bootloader with a software update.

4.10.1 The Bootloader

The bootloader mode is used only for transferring software updates. While a control module is in the bootloader, the function of the module is deactivated. It is not possible to switch outputs or communicate via the fieldbus. The bootloader mode is visualized via the LED display. The different displays can be found in the section *LED Display*.

4.10.2 Software update ControlUnit

Figure 66: Installation directory control unit Bootloader

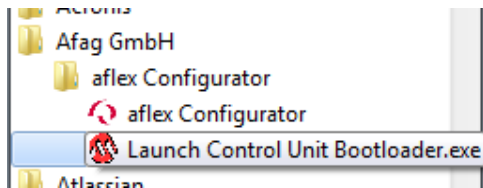

The software update of the control unit differs from that of the client nodes. It is performed using the application "control unit Bootloader" installed with the "aflexConfigurator". The application can be found in the Afag GmbH folder via the start menu. Proceed as follows:

- Start the application "Control unit Bootloader".

Figure 67: Software update ControlUnit 1

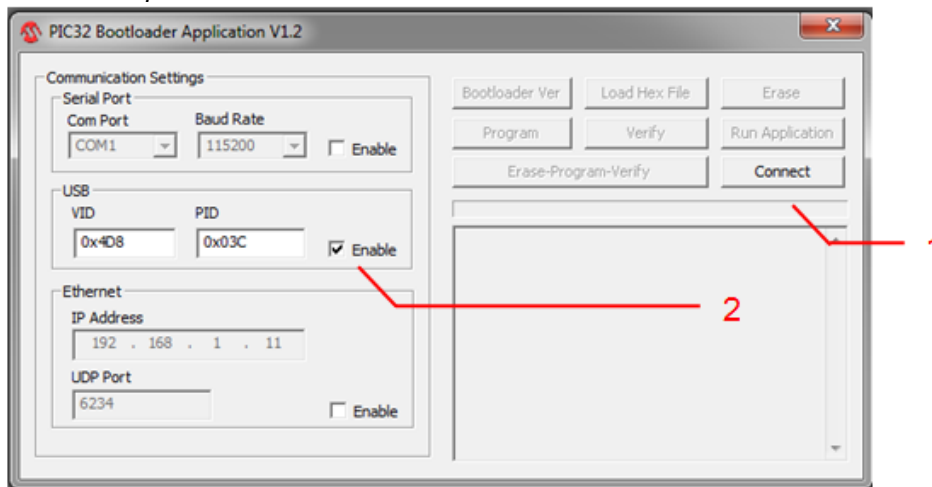

- (1) Establish connection
- (2) Activate USB connection

- Activate the USB connection (2) and connect the control unit to the computer with a USB cable.
- To perform an update, the control unit must be in the "Bootloader Mode". This is activated in the "aflexConfigurator" in the sub-menu of the control unit. Further information can be found in "Sub menu controller".

- In order for the bootloader to become active, the control unit must be re-started. In the "aflexConfigurator", execute a restart of the control unit via the "Restart Controller" button.
- The bootloader is active, the three status LEDs flash in the same clock.

INSTRUCTION	
	<p>After each reboot, the bootloader mode is activated in the control unit for only 15 seconds. The control unit then jumps back to the last software status. Make sure you start the transfer in these 15 seconds. Otherwise the control unit must be restarted.</p> <p><i>From hardware version v1.30 the time was increased to one minute.</i></p>

- Connect the bootloader application to the control unit using the "Connect" (2) button. After the connection is established, further options are enabled.

Figure 68: Software update ControlUnit 2

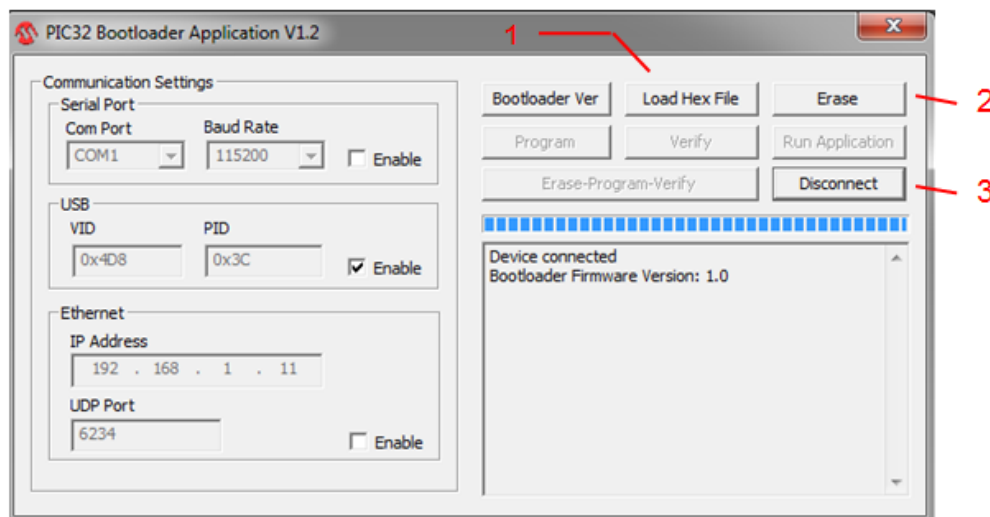

- (1) Select software update
- (2) Delete current program
- (3) Break connection

- First delete the current program via the "Erase" button (2). After the "Flash Erased" message was issued, a new software file can be played. Only the red and yellow LED will flash. In the event that the control unit exits the bootloader mode (LED does not flash any more), remove the 24V power supply at short notice and restart the control unit.
- Use the "Load Hex File" button to select the valid software update. The software file of control unit is named "ContorlUnit_FirmwarevXXX". The firmware

recorded in the delivery state can be found on the supplied USB stick in the directory "Firmware Files"

Figure 69: Software update ControlUnit 3

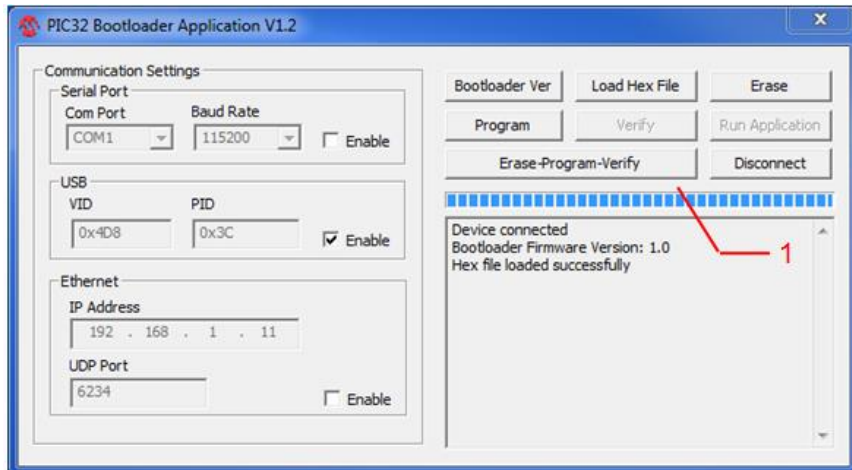

(1) Run software update

- Start the software update via the "Erase-Program-Verify" button (1). The bootloader application loads the new software update in the ControlUnit. After successful completion, the confirmation "Verification successful" is displayed, as shown in the following figure. The control unit automatically switches to the new program after the waiting time and can be configured via the "aflexConfigurator".

Figure 70: Software update ControlUnit 3

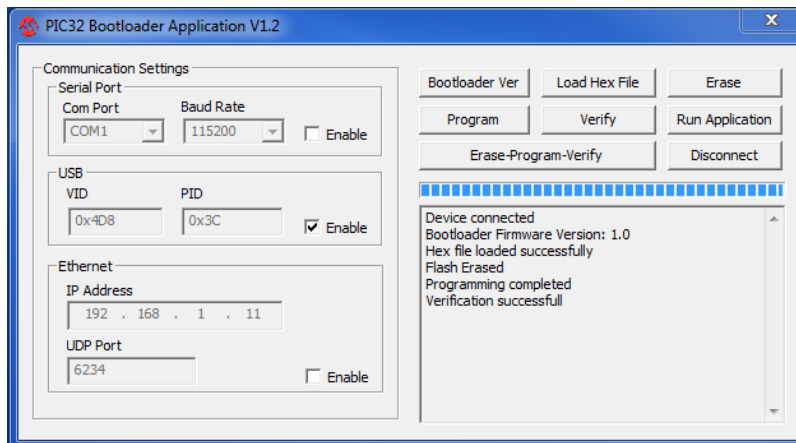

4.10.3 Software update Client Node

The software update of a client node is performed in the "aflexConfigurator". If the client node is in bootloader mode and the user level is "advanced", the corresponding menu is displayed in the client node.

Figure 71: Activate Bootloader

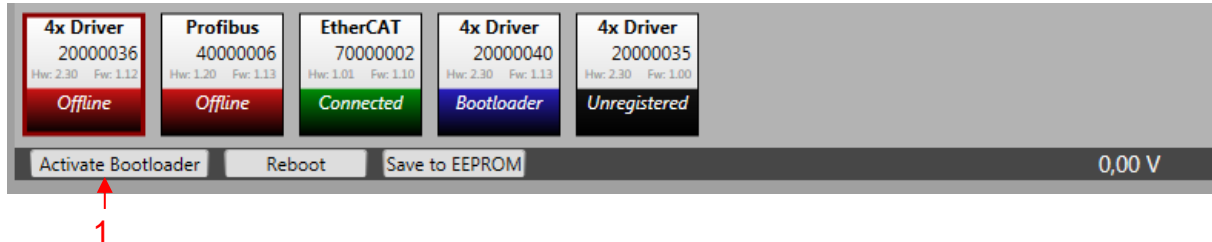

(1) Activate Bootloader

A prerequisite for the firmware update is the active bootloader mode of the client node. To activate it, the "activate Bootloader" function must be executed. This activates the bootloader and restarts the client node. When restarting, this does not change into the firmware but starts the boot loader program. If the client node is in the bootloader mode, the functions shown below are displayed.

Figure 72: Software update Client Node 1

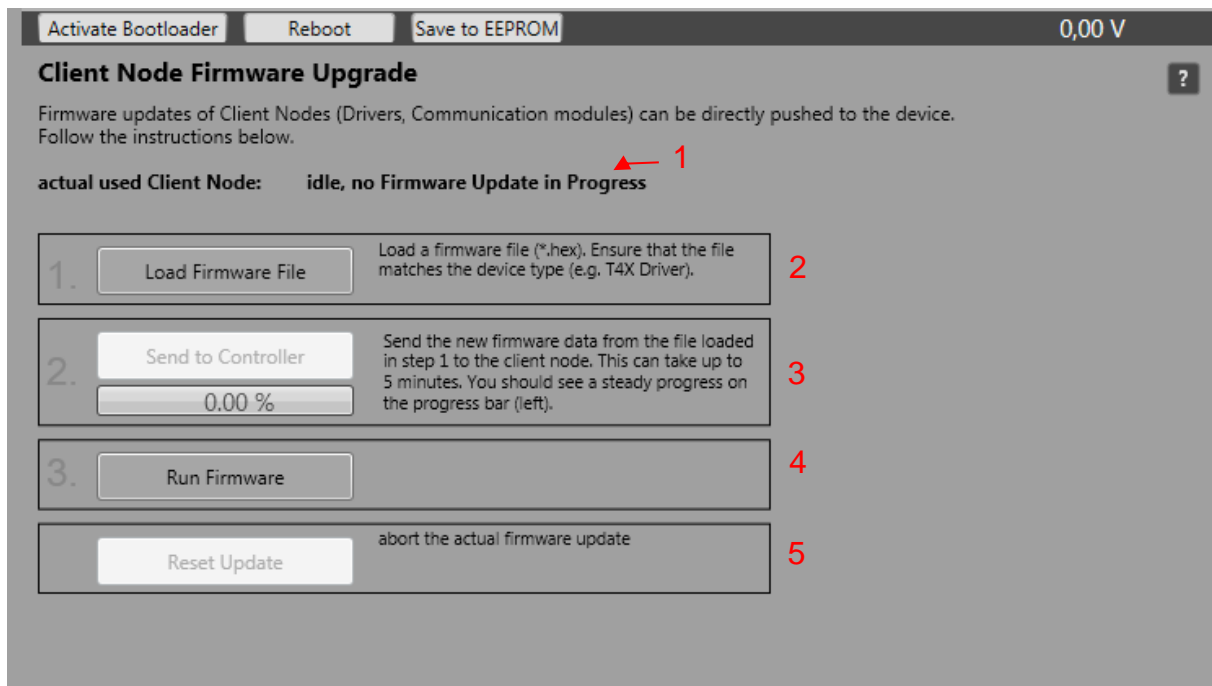

- (1) Firmware update process current client node
- (2) Select .hex firmware file
- (3) Start transfer
- (4) Start firmware
- (5) Cancel update firmware

Firmware update process current client node (1)

If a firmware update process is already active, the client node serial number used there is displayed.

INSTRUCTION	
	It is not possible to provide a firmware update for several client nodes simultaneously. For this reason, the currently used Client Node Serial is displayed.

Procedure for installing a new client firmware:

1. Select .hex firmware file (2)

The desired .hex firmware file must be selected. The correct client node type must be observed.

2. Start transfer (3)

If the firmware file is loaded, the display bar jumps to 100% and the button to start the transfer is released. By clicking on this, the flash memory of the client node is deleted and then the new firmware file is transferred.

3. Start firmware (4)

As soon as the firmware file has been transferred fully, the button for starting the firmware is released. Clicking on this activates the firmware of the client node. It is displayed as "connected" and the normal client node functions are available.

INSTRUCTION	
	If no valid firmware is present on the client node, this automatically returns to the bootloader mode.

4. Cancel update firmware (5)

If the firmware update is to be cancelled, this button is to be pressed. The current process is terminated. If data has already been transferred, the flash memory of the client node is deleted. A valid firmware must be transferred completely in order to run it outside the bootloader mode.

5 First commissioning

5.1 Assembly of the system

The aflex is mounted. Information about it can be found in the chapter Installation instructions and the accompanying Quick Guide.

The control unit is installed and connected according to the circuit diagram. Refer also to the chapter Installation instructions and the accompanying circuit diagram.

5.2 Connect to control unit

The configuration software "aflexConfigurator" must be installed. If the configuration software and the control unit are located in the same network, the control unit is found using the "Search" button. The Windows firewall can block this UDP broadcast depending on the company setting. If this is the case, there are two options.

1. Establish a direct connection between the computer and control unit with an Ethernet cable. Since the control unit is configured with the DHCP in the delivery state, no IP adjustments have to be made.
2. Add the IP address from the delivered test report manually using the "add control unit" function

Detailed information can be found in the section Software description .

5.3 Configure ControlUnit

The IP address & device name of the control unit is adapted to the application.

Detailed information can be found in the section Software description .

5.4 Configure client nodes

The control modules are preconfigured in the delivery state. All channels of the T4X drivers are in "Pulse Mode Continuous" and the "Channel Max Power" is set to the aflex actuator. The channel names are defined accordingly. These settings should not be changed during commissioning!

Detailed information can be found in the section Software description .

A new configuration is necessary only in the case of a driver exchange or an aflex exchange. In these cases, following care must be taken:

- The maximum power of the actuators is adjusted in the resonance frequency of the aflex so that no mechanical contact is created between the vibrating plate and the frame. The noise level of the aflex increases significantly with a slight mechanical contact, and the vibration plate can be heard. If the power of the actuator is further increased, the vibration plate remains attached to the frame and the vibrations are almost completely damped. In these cases, the maximum intensity of the actuator must be reduced.

5.5 Configure software modules

The aflex software module is already configured in the delivery state. The T4X client nodes are assigned to the individual channels. Two configurations are already predefined. One configuration is suitable for separating components ("flip") the second for conveying components ("move"). These configurations may need to be adapted to the application components.

Detailed information can be found in the section Software description .

5.6 Integration with higher control

In order to communicate with the higher-level controller in automatic mode, the fieldbus interface is used; this is not preconfigured in the delivery state. Detailed information on how a fieldbus input or output is created can be found in the section Software description.

Different standard fieldbus configurations are stored in the aflexConfigurator. It is recommended to use these for the control. Delivered configuration files, for e.g. the device description file for EtherCAT are created for this configuration. The following commands are included in the standard configurations.

Table 10 *important commands for controlling aflex*

Command Name	Description
Load Config Number	<p>Loads the appropriate configuration. The transferred configuration slot is activated.</p> <p>No action is executed for a "0" or a configuration number that was not defined. The field bus output "Load Config Number" still shows the last configuration that was loaded.</p>
Light Intensity	Available on all "qc" products with an integrated back light. Back light actuation.
Controller Restart	Initiates a restart of the ControlUnit. This is performed as soon as "Restart" signal is reset from "1" to "0".
Auto mode	<p>Optional Command</p> <p>Change-over option between automatic/manual mode.</p> <p>Manual mode (value 0): Parameters can only be changed using the "aflex Configurator".</p> <p>Automatic mode (value > 0): Parameters can only be changed via the field bus interface.</p> <p>If the configurator is connected, the field bus cannot be used to change over the operating mode.</p>

	<p>After disconnecting the TCP/IP connection to the “aflex Configurator”, the ControlUnit changes to automatic mode. The ControlUnit also changes to automatic mode after each re-start.</p> <p>If the command is linked in the field bus configuration, it must be set for to activate “automatic” mode. If not, then the ControlUnit will switch to “manual mode”.</p>
Set General Release	<p>General release without which all power outputs and the back light are deactivated. Must be set in order to use the aflex.</p> <p>This command can be used optionally for ControlUnit Firmware version v1.52 and higher. If the “General Release” is not linked in the field bus configuration, then the “General Release” is set automatically when changing to “automatic mode”.</p> <p>The command cannot be removed and must be actuated for the EtherCAT and Profinet interface.</p>
Intensity	<p>Actuation intensity of the aflex.</p> <p>If it is greater than “0”, the aflex is actuated with the currently selected direction and activated configuration. Set to “0” to shut off the aflex.</p>
Direction	<p>This function is not available if an aflex Iv product is used. If the command is linked in the field bus configuration, the designation “Direction - not available” is displayed.</p>

All power outputs require the general release. If this input is not set, they remain switched off.

By selecting different predefined configurations, different parameter sets can be changed. This may be of advantage for e.g. in the case of a change of variants or an alternative component handling (a change from separating to conveying). As soon as a new configuration number is transferred to the aflex input, the control unit switches the parameters.

As a rule, a distinction is made between a conveyor configuration and a flip configuration during the control. A different frequency range is suitable for conveying than to separate the components. In addition, the horizontal actuators are deactivated when separating. This is converted to 0 by limiting its maximum intensity. The selected configuration is active until the transferred number on the fieldbus input changes or the configuration is manually reloaded in the "aflexConfigurator".

The aflex is controlled by two commands. The specification of a control intensity and the specification of a direction of movement. If the horizontal actuators are deactivated during a "flip configuration", the transfer value of the direction of movement has no

effect. As soon as the control intensity is set > 0 , the aflex is controlled and vibrated. If the intensity is reset to 0, the aflex is switched off.

The option to convey components and thus to specify the motion direction is not available if an aflex lv is used.

5.6.1 Development of transfer values

Due to the various fieldbus interfaces, the command range of the individual commands is variable. Depending on the interface, commands of 1-32 bits can be widely defined. Depending on the defined command range, the transmission values must be calculated. For this reason, a command range of 8-16-32 bits is recommended when using a Profibus interface. An example of the calculation of the transfer value, depending on the defined command range using the intensity command:

The aflex intensity is controlled from 0-100%. Where 100% is the maximum possible value. For a 16-bit command, therefore, 65535. The transfer value can be calculated using the following formula:

$$\text{Max Value 8Bit} = 255$$

$$\text{Max Value 16Bit} = 65535$$

$$\text{Max Value 32Bit} = 4294967295$$

$$\text{Value} = \frac{\text{Max Value}}{100\%} * \text{target percentage}[\%]$$

If the intensity (defined as 16Bit wide) is set to 75%, the value "49151" must be transmitted.

A special case is the vibration frequency, which is transmitted in heart [Hz] by a factor of 10. Thus, a frequency of 56.4 Hz corresponds to a value of 564. For this reason, the frequency must be addressed with at least 16 bits. However, the vibration frequency of the aflex is generally not separately controlled, since this is already set when loading a configuration.

The option to convey components and thus to specify the motion direction is not available if an aflex 400 lv or aflex qc light is used.

5.6.2 Digital input/output

The control unit has eight 24V DC digital inputs and outputs. The following figure shows an integration to a "customer device".

Figure 73: Digital IO Connection

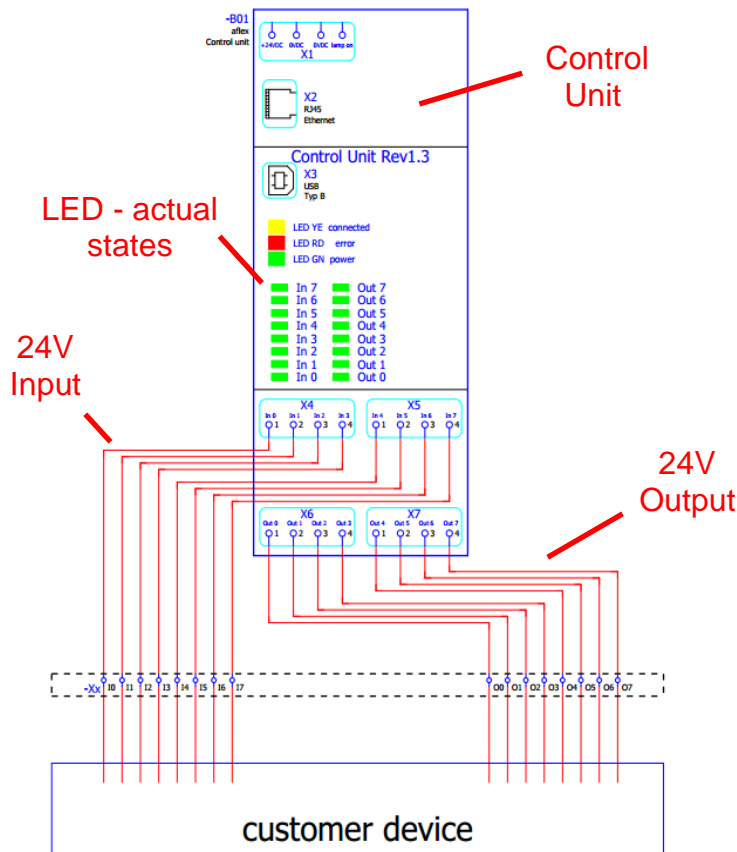

In contrast to other fieldbus interfaces, the "load config #" command must be used instead of the "load config number" command to load a configuration using the digital IO.

Table 11: Digital IO Commands

Command name	Description
Load Config #1	In the control unit various aflex configurations can be stored. This allows you to quickly switch between separating, conveying or alternatively changing configurations for different work pieces. With the commands Load Config #x, the corresponding configuration is loaded with a rising flank. These commands allow you to load a configuration without using 8 bits for the LoadConfigNumber command.
Load Config #2	
Load Config #3	
Load Config #4	
Load Config #5	

Because only eight digital inputs are available, the possibilities to integrate the aflex are limited. Two different strategies are described in more detail below.

Strategy 1:

Components are not supported at all, but up to three different configurations can be called up. The intensity can be controlled in seven steps from 0-100%.

Strategy 2:

Components can be separated and conveyed with two configurations. The intensity can only be set here from 0% to 100%.

Strategy 3: (available from ControlUnit Firmware v1.40)

Components can be separated and conveyed with two configurations. The intensity can be adjusted from 0% to 100% in several steps.

INSTRUCTION	
	<p>From ControlUnit Firmware v1.40 the „Direction“ Control is improved for digital In/Outputs. From this Version strategy 3 is possible.</p>

Calculation of the direction value when using digital In-/Outputs from ControlUnit Firmware v1.40.

$$Direction\ Value = \frac{Max\ Value + 1}{360} * target\ direction[^\circ]$$

INSTRUCTION	
	<p>In 90% of the applications it is sufficient to separate the components by vibrations. Conveying components is often not necessary. Here strategy 1 should be followed.</p>

INSTRUCTION	
	<p>In alternative control interfaces such as TCP / IP or Profibus, these limits do not exist, and e.g. up to 50 configurations can be used.</p>

5.6.2.1 Strategy 1

No conveying of components is given up. Components are merely isolated. In this case, the "Direction" command is not required. For this, there is the possibility to call up more different configurations and to control the intensity steps. If it is mandatory to promote the development of components, Strategy 2 must be applied.

The digital inputs are defined as follows.

Input	0	1	2	3	4	5	6	7
Command	General Release	Aux Power Output	Load Config #1	Load Config #2	Load Config #3	Intensity LSB	Intensity	Intensity MSB

The possible states are described below. The formulas for calculating the intensity and direction can be found in the operating manual.

General Release	Status "0" (0V):	No release
	Status "1" (24V):	Present release
Aux Power Output	Status "0" (0V):	Background lighting off, light intensity = 0%
	Status "1" (24V):	Background lighting on, light intensity = 100%
Load Config #1	Status "0" (0V):	No action
	Status "1" (24V):	With rising flank load the configuration slot "1"
Load Config #2	Status "0" (0V):	No action
	Status "1" (24V):	With rising flank load the configuration slot "2"
Load Config #3	Status "0" (0V):	No action
	Status "1" (24V):	With rising flank load the configuration slot "3"
Intensity	Status "000" (0V,0V,0V):	0% Intensity = aflex switched off
	Status "100" (0V,0V,0V):	14% Intensity
	Status "010" (0V,24V,0V):	28% Intensity
	Status "110" (24V,24V,0V):	42% Intensity
	Status "001" (0V,0V,24V):	57% Intensity
	Status "101" (24V,0V,24V):	71% Intensity
	Status "011" (0V,24V,24V):	85% Intensity
	Status "111" (24V,24V,24V):	100% Intensity

In the aflexConfigurator, you must configure the fieldbus interface as shown in the following figure. By defining the outputs equal to the inputs, you get a response about the current values of the aflex system.

Figure74: Fieldbus Configuration IO Type1

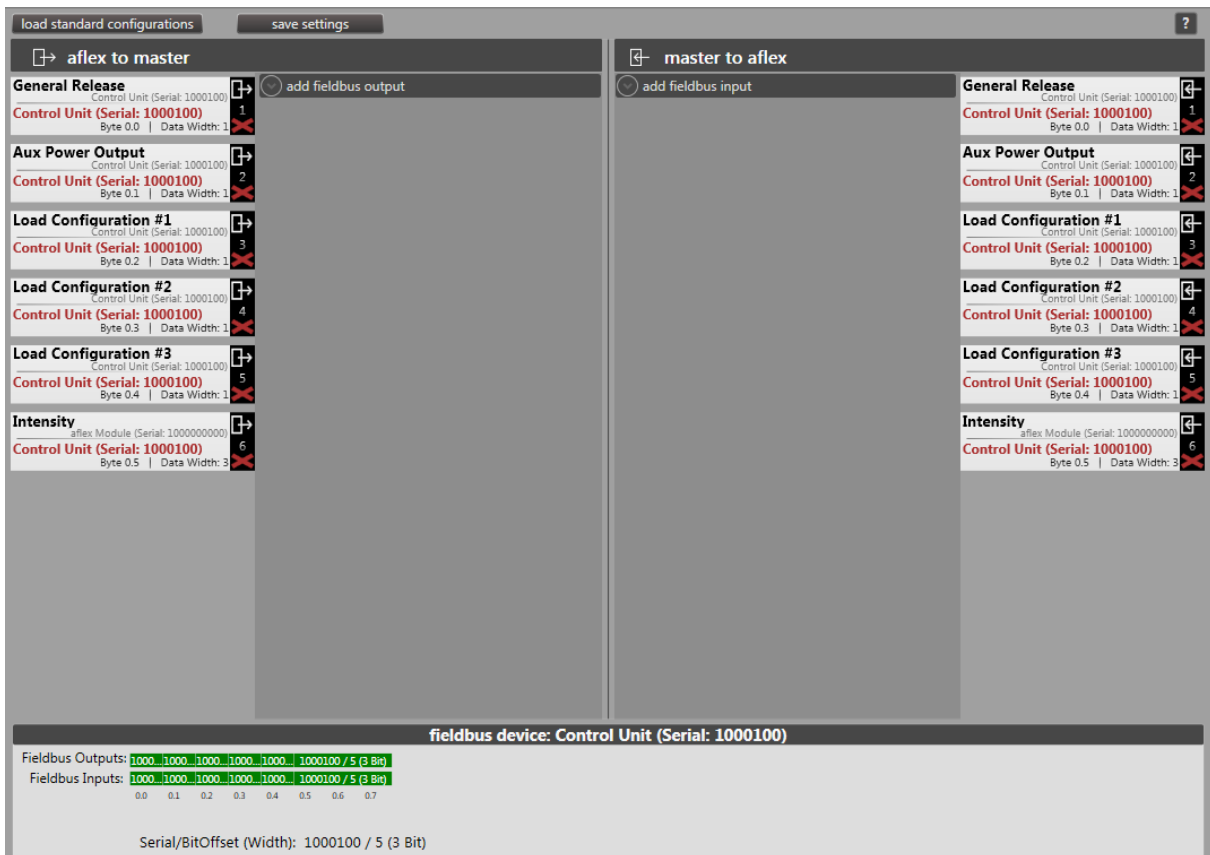

Because the Direction command is not controlled in this strategy, it is important to set the Horizontal Max Power to 0%. In this way, the configuration is independent of the direction since the horizontal actuators are deactivated. The following figure shows the corresponding slider from the sub-menu "control interface".

Figure 75: Digital IO Typ1 horizontal max. power setting

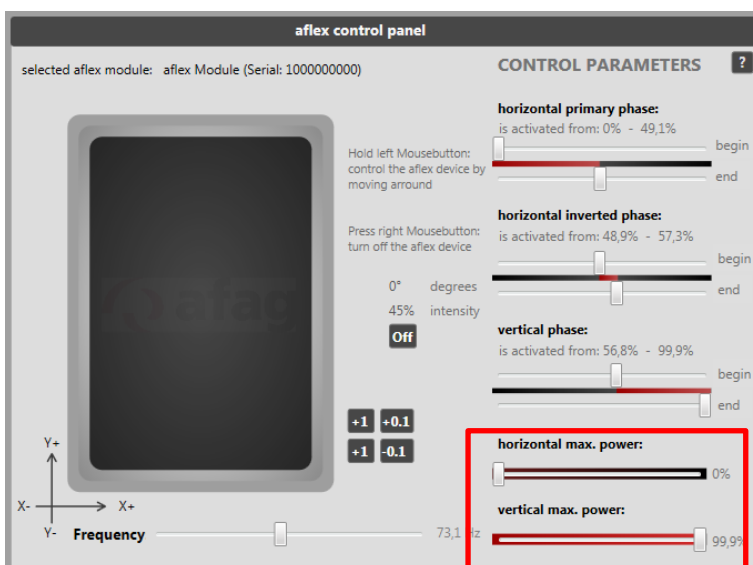

5.6.2.2 Strategy 2

There is the possibility to convey the components in different directions, but only two configurations can be called and the intensity can not be controlled level-wise.

Input	0	1	2	3	4	5	6	7
Command	General Release	Aux Power Output	Load Config #1	Load Config #2	Intensity	Direction LSB	Direction	Direction MSB

The possible states are described below. The formulas for calculating the intensity and direction can be found in the operating manual.

General Release	Status "0" (0V):	No release
	Status "1" (24V):	Present release
Aux Power Output	Status "0" (0V):	Background lighting off, light intensity = 0%
	Status "1" (24V):	Background lighting on, light intensity = 100%
Load Config #1	Status "0" (0V):	No action
	Status "1" (24V):	With rising flank load the configuration slot "1"
Load Config #2	Status "0" (0V):	No action
	Status "1" (24V):	With rising flank load the configuration slot "2"
Intensity	Status "0" (0V):	0% Intensity = aflex switched off
	Status "1" (24V):	100% Intensity
Direction	Status "000" (0V,0V,0V):	0° Conveying direction
	Status "100" (24V,0V,0V):	51° Conveying direction
	Status "010" (0V,24V,0V):	102° Conveying direction
	Status "110" (24V,24V,0V):	154° Conveying direction
	Status "001" (0V,0V,24V):	205° Conveying direction
	Status "101" (24V,0V,24V):	257° Conveying direction
	Status "011" (0V,24V,24V):	308° Conveying direction
	Status "111" (24V,24V,24V):	360° Conveying direction

INSTRUCTION



From ControlUnit Firmware v1.40 the direction Control is optimized for digital Inputs. Following table is valid.

From ControlUnit Firmware 1.40

Direction	Status „000“ (0V,0V,0V):	0° Conveying direction
	Status „100“ (24V,0V,0V):	45° Conveying direction
	Status „010“ (0V,24V,0V):	90° Conveying direction
	Status „110“ (24V,24V,0V):	135° Conveying direction
	Status „001“ (0V,0V,24V):	180° Conveying direction

Status „101“ (24V,0V,24V):	225° Conveying direction
Status „011“ (0V,24V,24V):	270° Conveying direction
Status „111“ (24V,24V,24V):	315° Conveying direction

In the aflexConfigurator, you must configure the fieldbus interface as shown in the following figure. By configuring the outputs equal to the inputs, you get a response about the current values of the aflex system.

Figure 76: Fieldbus Configuration IO Type 2

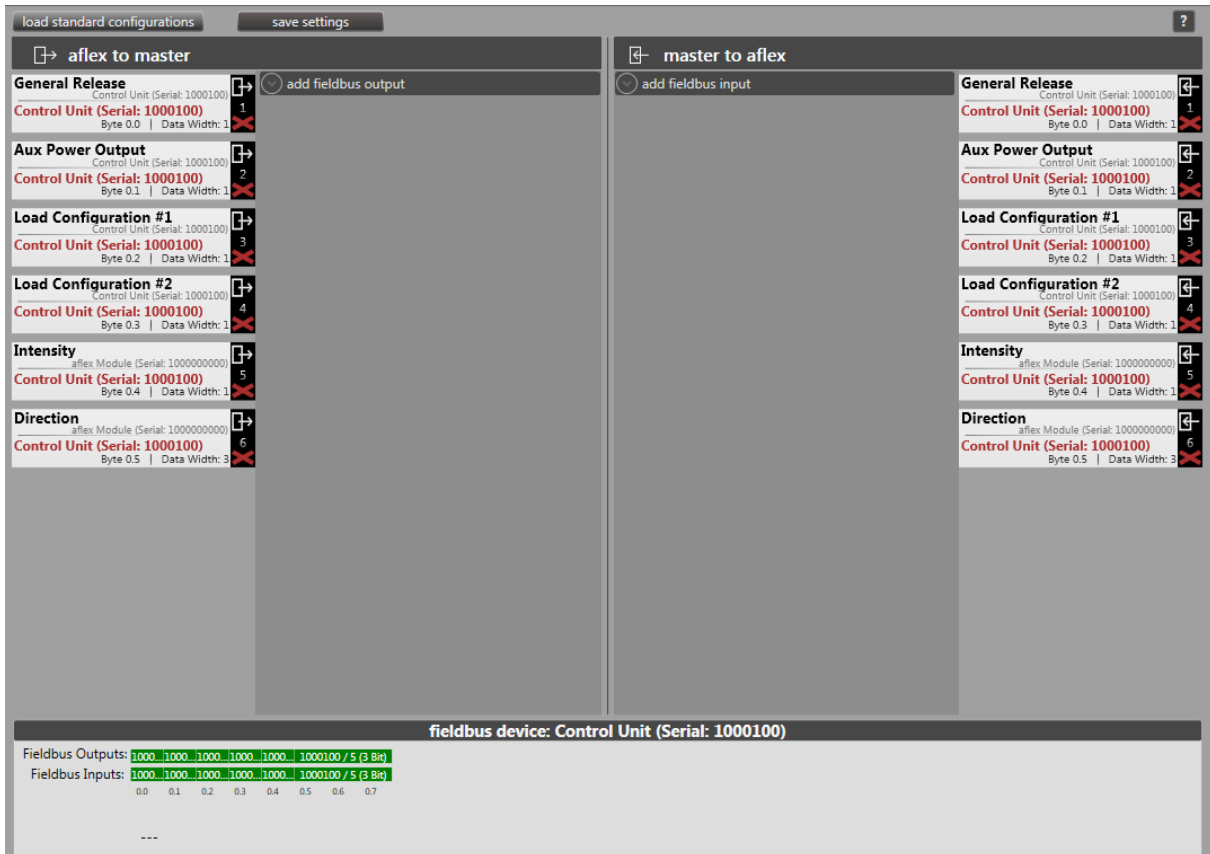

The screenshot displays the aflexConfigurator interface for fieldbus configuration. It features two main panels: 'aflex to master' on the left and 'master to aflex' on the right. Both panels list various control units with their serial numbers, byte addresses, and data widths. The 'aflex to master' panel includes 'General Release', 'Aux Power Output', 'Load Configuration #1', 'Load Configuration #2', 'Intensity', and 'Direction'. The 'master to aflex' panel mirrors these with corresponding input configurations. At the bottom, a status bar shows 'fieldbus device: Control Unit (Serial: 1000100)' and provides a visual representation of fieldbus outputs and inputs across a range of addresses (0.0 to 0.7).

5.6.2.3 Strategy 3

INSTRUCTION	
	From ControlUnit Firmware v1.40 useable

There is the possibility to convey the components in different directions and separate them. The configuration 1 is used to separate, the configuration 2 is used for convey the parts. The intensity can be controlled level-wise.

Input	0	1	2	3	4	5	6	7
Command	General Release	Aux Power Output	Load Config #1	Load Config #2	Direction LSB	Direction MSB	Intensity LSB	Intensity MSB

The possible states are described below. The formulas for calculating the intensity and direction can be found in the operating manual.

General Release	Status "0" (0V):	No release
	Status "1" (24V):	Present release
Aux Power Output	Status "0" (0V):	Background lighting off, light intensity = 0%
	Status "1" (24V):	Background lighting on, light intensity = 100%
Load Config #1	Status "0" (0V):	No action
	Status "1" (24V):	With rising flank load the configuration slot "1"
Load Config #2	Status "0" (0V):	No action
	Status "1" (24V):	With rising flank load the configuration slot "2"
Direction	Status „00“ (0V,0V):	0° Conveying direction
	Status „10“ (24V,0V):	90° Conveying direction
	Status „01“ (0V,24V):	180° Conveying direction
	Status „11“ (24V,24V):	270° Conveying direction
Intensity	Status „00“ (0V,0V):	0% Intensity = aflex switched off
	Status „01“ (0V,24V):	33% Intensity
	Status „10“ (24V,0):	66% Intensity
	Status „11“ (24V,24V):	100% Intensity

Figure 77: Fieldbus Konfiguration IO Typ 3

load standard configurations
save settings
?

aflex to master

show values
add fieldbus output

General Release	Control Unit (Serial: 10000051)	1
Control Unit (Serial: 10000051)	Byte 0.0 Data Width: 1	✖
Light Intensity	Backlight Node (Serial: 50000015)	2
Control Unit (Serial: 10000051)	Byte 0.1 Data Width: 1	✖
Load Configuration #1	Control Unit (Serial: 10000051)	3
Control Unit (Serial: 10000051)	Byte 0.2 Data Width: 1	✖
Load Configuration #2	Control Unit (Serial: 10000051)	4
Control Unit (Serial: 10000051)	Byte 0.3 Data Width: 1	✖
Intensity	aflex Module (Serial: 1000000000)	5
Control Unit (Serial: 10000051)	Byte 0.4 Data Width: 2	✖
Direction	aflex Module (Serial: 1000000000)	6
Control Unit (Serial: 10000051)	Byte 0.6 Data Width: 2	✖

master to aflex

add fieldbus input
show values

General Release	Control Unit (Serial: 10000051)	1
Control Unit (Serial: 10000051)	Byte 0.0 Data Width: 1	✖
Light Intensity	Backlight Node (Serial: 50000015)	2
Control Unit (Serial: 10000051)	Byte 0.1 Data Width: 1	✖
Load Configuration #1	Control Unit (Serial: 10000051)	3
Control Unit (Serial: 10000051)	Byte 0.2 Data Width: 1	✖
Load Configuration #2	Control Unit (Serial: 10000051)	4
Control Unit (Serial: 10000051)	Byte 0.3 Data Width: 1	✖
Intensity	aflex Module (Serial: 1000000000)	5
Control Unit (Serial: 10000051)	Byte 0.4 Data Width: 2	✖
Direction	aflex Module (Serial: 1000000000)	6
Control Unit (Serial: 10000051)	Byte 0.6 Data Width: 2	✖

fieldbus device: Control Unit (Serial: 10000051)

Fieldbus Outputs: 1000...1000...1000...1000...10000051 /- 10000051 /-

Fieldbus Inputs: 1000...1000...1000...1000...10000051 /- 10000051 /-

0.0 0.1 0.2 0.3 0.4 0.5 0.6 0.7

5.6.3 Telnet-Server

In addition to the digital inputs / outputs, the control unit has a Telnet server. Like the digital inputs / outputs, the configured fieldbus interfaces are addressed. The bit address can be used to access each input / output. The port of the Telnet server is defined via the menu of the control unit in the "aflexConfigurator". By default, this is preconfigured on port 23. The Telnet server is activated or deactivated in the same menu.

Figure 78: *Telnet Configuration*

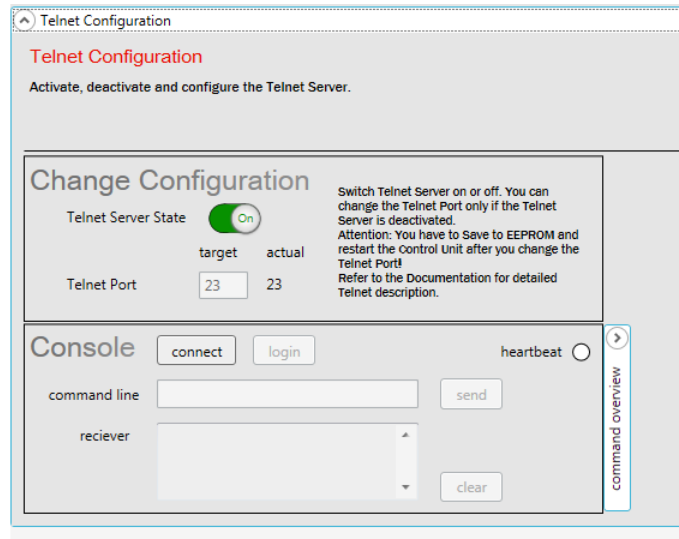

Console

A Telnet connection can be tested in the console. The connection is established via the "connect" & "login" button, the "heartbeat" shows the existing connection. A brief description of the Telnet protocol is stored in the "command overview".

Telnet-Protocol

The Telnet protocol based on the ASCII code. An empty space (0x20) is used as a separator. At the end of each command, a "Carriage Return" (0x0D) & "Line Feed" (0x0A) is necessary.

Login

To log on to the Telnet server, a user name and password must be transferred. After the connection is established, the Telnet server requested a user name via "TU\r\n" Type User. The password is then requested by means of "TP\r\n" type password. After successful login, the server logs "LI 1\r\n" Login "true" or "LI 0\r\n" Login "false" for incorrect logging. To log in, use the following user & password:

User name: "Admin"

Password: "Telnet Server"

A command is defined as follows:

Table 12: Definition Telnet-Commands

Command	Separator	Bit dress	Ad-	Separator	Value	CR LF
SI	Space	XXX		Space	XXXXXXXXXX	\r\n
GO	Space	XXX				\r\n

Set Input "SI"

An input of the aflex system is set via the Set Input command. This is defined by the bit address. The transferred value is set as new. The value and bit address is passed ASCII-coded. A bit address up to address 999 is possible. Depending on the configuration of the interface, it is possible to transfer a value with up to 32 bits.

For example, the following input is defined in the interface.

- Destination: "Intensity" on the aflex-Module (Serial: 10 00 00 00 00)
- Bit address 40 (byte address 5.0)
- Bit width 32 bits

The aflex is to be controlled with an intensity of 80%. This corresponds to a value of 32 bit width of: "3435973836"

The following command must be passed via telnet:

`"SI 40 3435973836\r\n"`

The telnet server reports the following acknowledge:

`„AK 40 3435973836\r\n “`

INSTRUCTION



ControlUnit Firmware v1.52 and higher:

If the ControlUnit is in "manual" operating mode, the response "ER 5" is given for all Telnet commands, with the exception of "Auto mode".

If the "Auto Mode" command is sent, the Telnet server responds with the AK response. Because switching over from "manual" to "automatic" is not possible if the aflex configurator is connected, the AK response in this case is "AK x 0" (x=Bitoffset).

Get Output "GO"

An output of the aflex system is queried via the "Get Output" command. The output to be queried is also addressed via the bit address.

For example, the following output is defined in the interface.

- Output value: „Intensity“ from aflex-Module (Serial: 10 00 00 00 00)
- Bit address 72 (byte address 9.0)
- Bit width 16 bits

To query the output, the following command must be passed:

`"GO 72CRLF"`

The response of the Telnet server at an actual intensity of 80% is as follows:

`"RO 72 52428\r\n"`

ER Error notification

If a faulty structure is transferred to the Telnet server, it sends an error message. The Telnet server distinguishes between the following errors.

Table 13: *Telnet error codes*

Error code	Designation
2	Faulty command
3	Faulty value
4	Faulty Bit Address
5	From firmware version 1.52: Faulty operating mode. ControlUnit is not in "automatic" mode. Command was not processed.

The error message for a non-existent or incorrect bit address is defined as follows:

`"ER 4\r\n"`

Logout

To terminate the connection via a command,

`"LO \r\n"` is sent. Please note that a space must be inserted after the LO. The message `"LI 0\r\n"` confirms the successful disconnect of the connection.

Heartbeat

The Telnet server cyclically sends a "heartbeat" during an existing connection. If this is not received by the client, the Telnet server will terminate the connection. The "Heartbeat" is built as follows:

`"HBT 1" / "HBT 0"` The bit is changed between 1 and 0 for each "Heartbeat".

In this case, no CR and LF are sent.

Overview of Telnet commands

Table 14: Overview *Telnet* commands

Command	Description	Reaction
SI	Set Input: An input is set	ACK message of the Telnet server with the current value
GO	Get Output: Query of output	RO message of the Telnet server with the current value
RO	Read Output: Message of the Telnet server with a current output value	Is sent only after a GO request
AK	Acknowledge: Acknowledgement of the Telnet server after setting an input	Is sent only after a SI command
ER	Error message of the Telnet server including error code	For details see ER error message
LO	End the connection using a command	The Telnet server is disconnected
HBT	Heartbeat of the Telnet server for querying the connection	If connection terminations are detected, the Telnet server closes the current connection. A new connection can be established.

5.6.4 Profibus module

As an alternative to the two standard interfaces, digital I/O and TCP/IP, there is the option of an optional Profibus interface. This is offered by your Profibus module. Like the two T4X driver modules, this module is connected to the control unit via the back-side bus. The Profibus module has a 9-pole SUB-D socket for communication with the master.

Figure 79: Profibus module

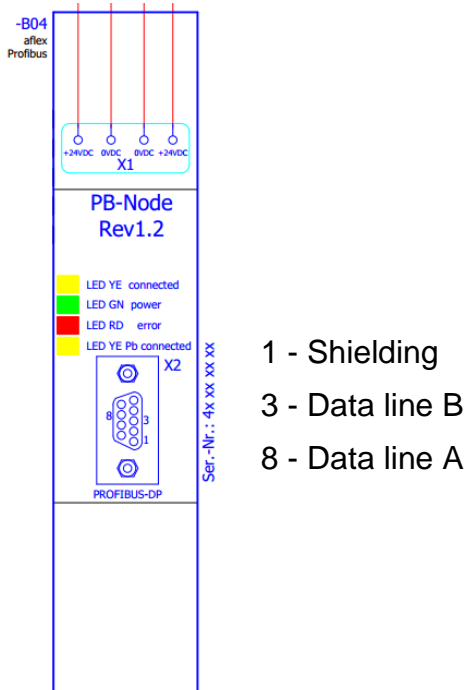

It is recommended to use the predefined standard Profibus Fieldbus configuration for the control. This is loaded via the function "load standard configurations" in the sub-menu "fieldbus config".

An example configuration of the above mentioned commands is shown in the following figure.

Figure 80: Profibus module FieldbusConfig

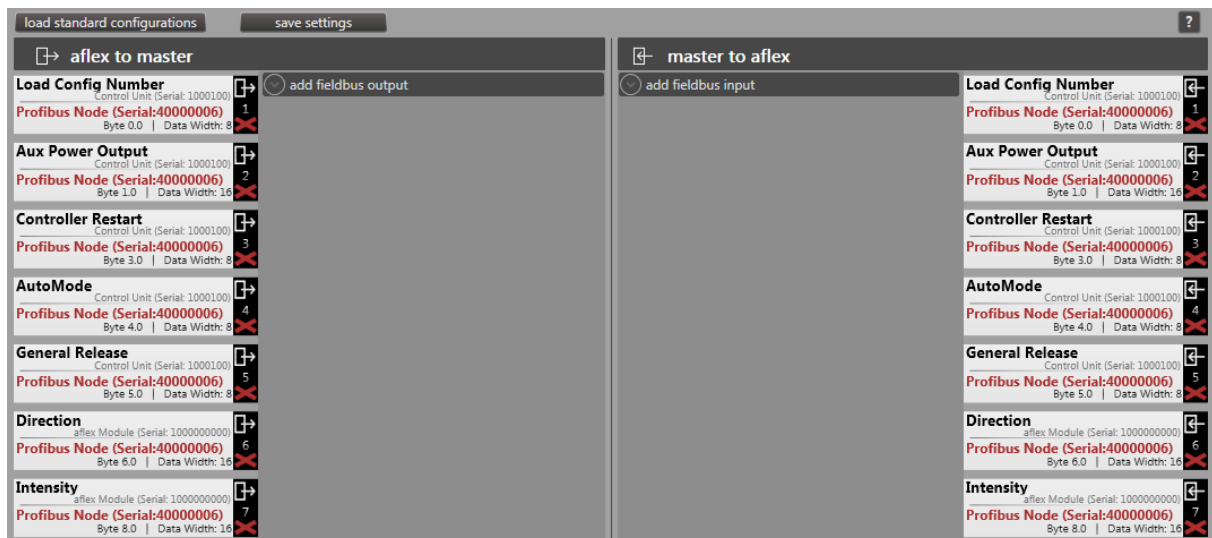

In order to establish a connection via the Profibus, an ID and a maximum available data range are assigned to the Profibus module. In this example, ID 7 and a maximum of 32 byte input/output data. These settings must match the settings of the Profibus master.

Figure 81: Profibus module Settings

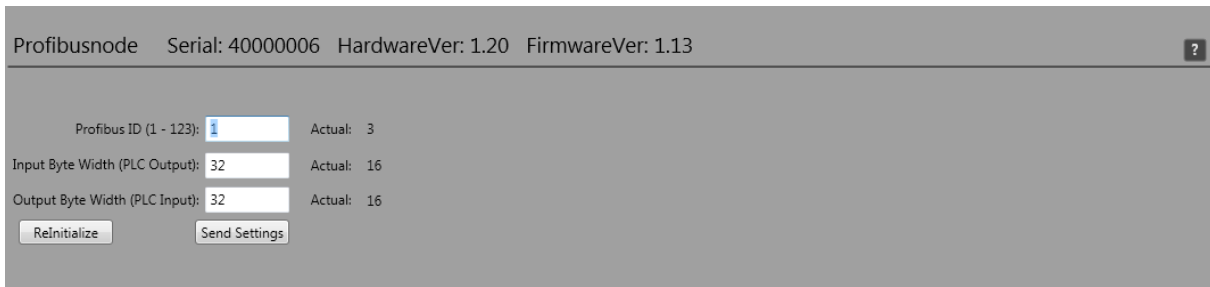

The aflex is integrated into the higher-level control via the supplied .GSD file. As in the aflexConfigurator, the corresponding input and output range must be defined. Various input module or output module or input-output modules are available for this purpose. In this example, two 16 byte DIO modules are used.

Figure 82: Profibus module SPS Integration

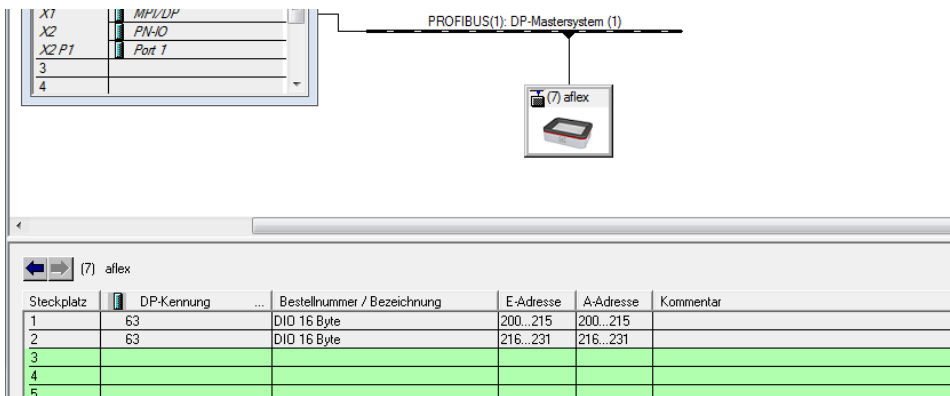

With these configurations, the individual commands are addressed with the following addresses and command lengths.

Address	Command lengths	Command
200	1 Byte	Load Config Number
201	2 Byte	Aux Power Output
203	1 Byte	Controller Restart
204	1 Byte	AutoMode:
205	1 Byte	General Release
206	2 Byte	Direction
208	2 Byte	Intensity

5.6.5 EtherCAT Module

As an alternative to the two standard interfaces, digital I/O and TCP/IP, there is the option of an optional EtherCAT interface. Like the two T4X driver modules, this module is connected to the control unit via the back-side bus. The EtherCAT module has an input port X2 and an output port X3.

Figure 83: EtherCAT Module

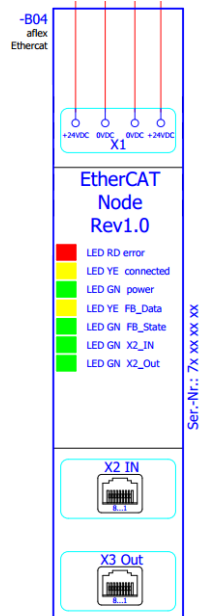

With the current aflexConfigurator software, the EtherCAT module can only be operated with the standard EtherCAT configuration. A flexible configuration of the inputs/outputs is currently not available. The device description file for EtherCAT supplied on the USB stick only works with the standard EtherCAT configuration. This configuration is loaded and activated via the "load standard configurations" function in the fieldbus menu. This configuration is shown below.

Figure 84: EtherCAT FieldbusConfig

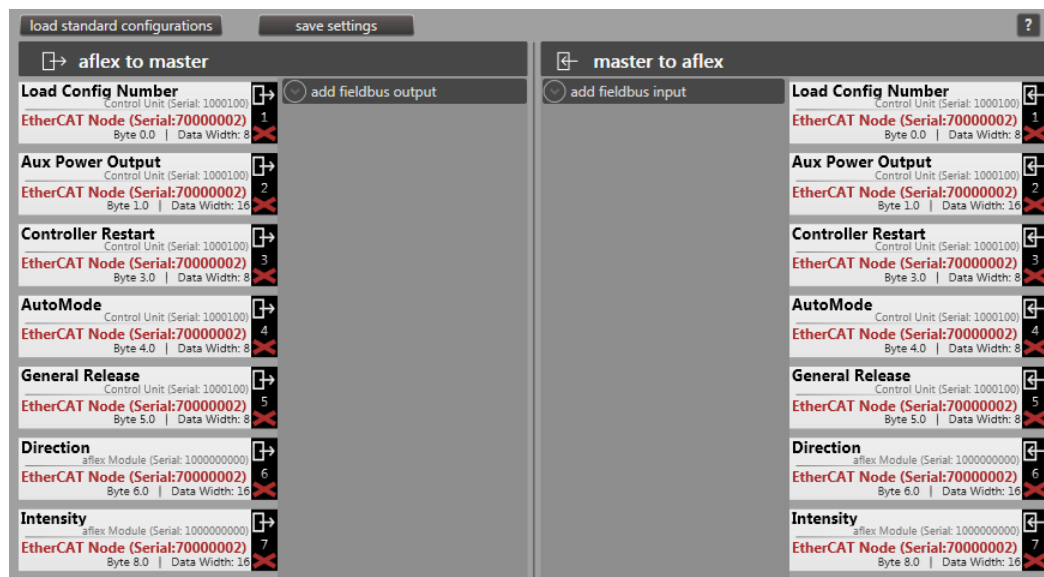

No additional settings need to be made in the EtherCAT Client Node. However, the current device status is displayed. A description of these functions can be found in the section.4.7.5

Figure 85: *EtherCAT Client Node Display*

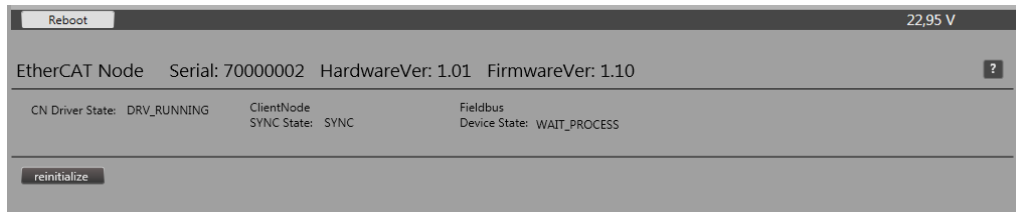

Integration of the interface in TwinCAT 3

1. Installation of the device description file
The device description file should be copied into the folder "C:\TwinCAT3.1\Config\Io\EtherCAT".
2. Create connection between SOS and EtherCAT interfaces
3. In TwinCAT3: E/A / Device / EtherCATMaster, right-click "Scan"

INSTRUCTION	
	<p>The device description file can be used together only with the standard EtherCAT Fieldbus configuration. See chapter Sub menu Fieldbus configuration.</p>

In addition to the "standard" inputs/outputs described in the previous section, there are still other commands. However, these are not required for the normal operation of the aflex. In the following, all fieldbus inputs/outputs are listed and briefly described.

5.6.6 Profinet Modul

As an alternative to the two standard interfaces, digital I/O and TCP/IP, there is the option of an optional Profinet interface. Like the two T4X driver modules, this module is connected to the control unit via the back-side bus. The Profinet module has two ports X2 and X3 to communicate with the Profinet system.

Figure 86: Profinet Modul

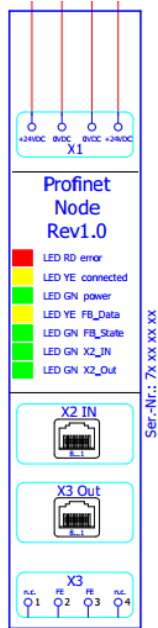

The „GSDML“ device description file describes the standard Profinet Configuration. This Configuration is loaded in the submenu “fieldbus menu” with the function “load standard configurations”

Figure 87: Profinet FieldbusConfig

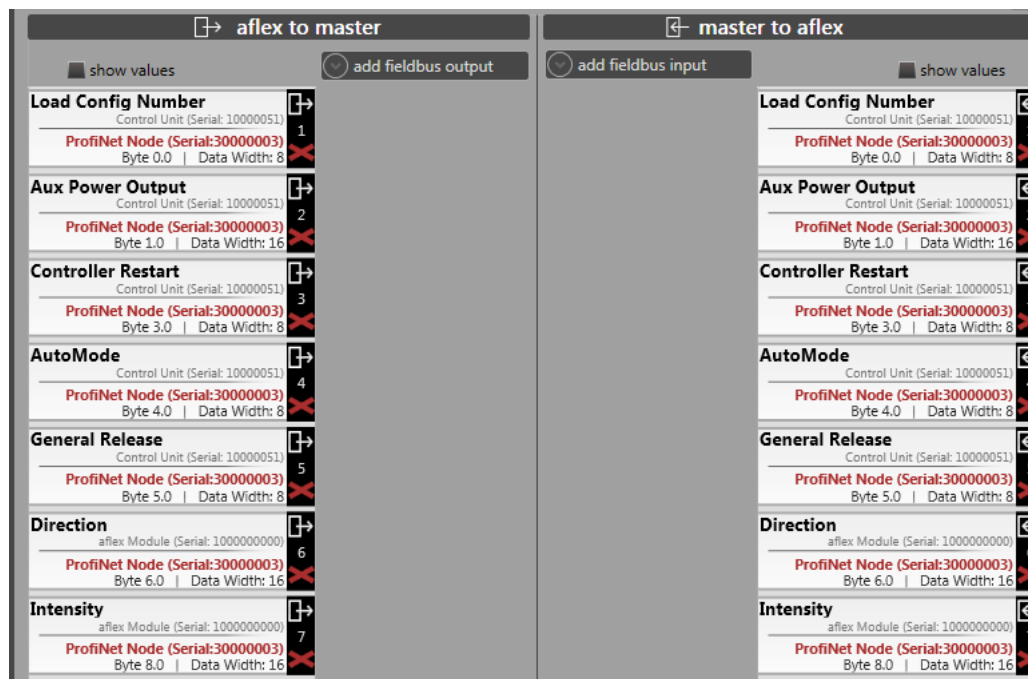

In the Profinet Client Node menu you can see the actual device states. There is detailed description in chapter 4.7.6.

Figure 88: *Profinet Client Node Anzeige*

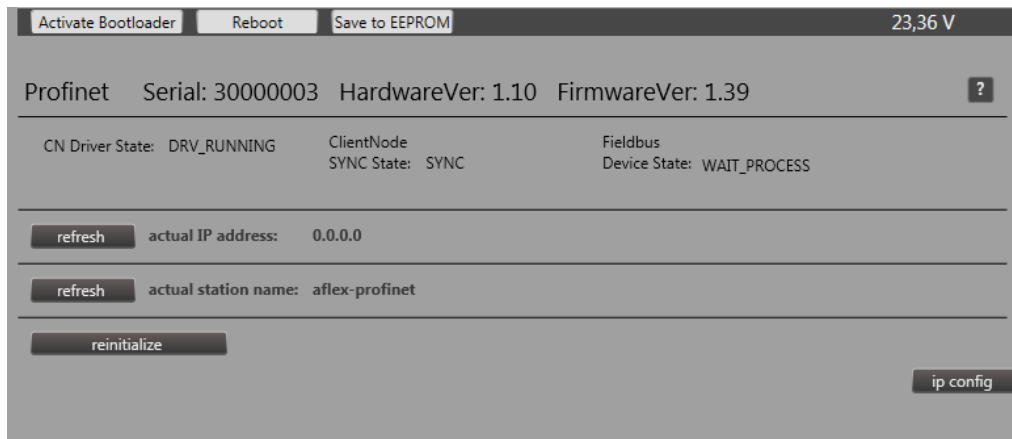

INSTRUCTION



The device description file can only be used with the standard Profinet fieldbus configuration.

5.6.7 EtherNet/IP Modul

This chapter describes the integration at a higher-level control with the optional EtherNet/IP module. It has two ports X2 and X3. The shielding of the Ethernet cable is connected to terminal X3.

Figure 89: EtherNet/IP Modul

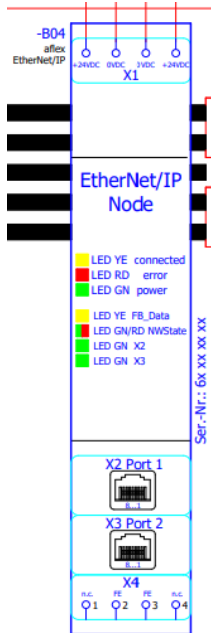

The EDS device description file of the EtherNet/IP module describes the standard EtherNet/IP configuration. This is loaded and activated via the function "load standard configurations" in the "fieldbus menu". This configuration is shown below.

Figure 90: EtherNet/IP FieldbusConfig

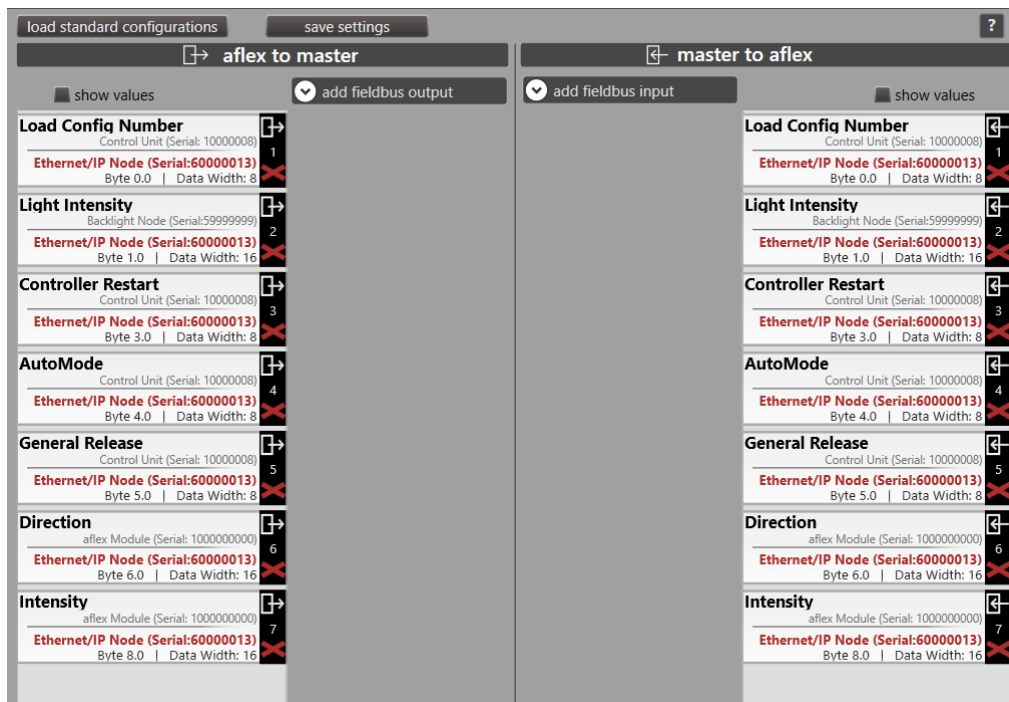

No additional settings have to be made in the EtherNet/IP Client Node. However, the current device statuses are displayed here. A description of these functions can be found in section 4.7.7.

Figure 91: *EtherNet/IP Client Node view*

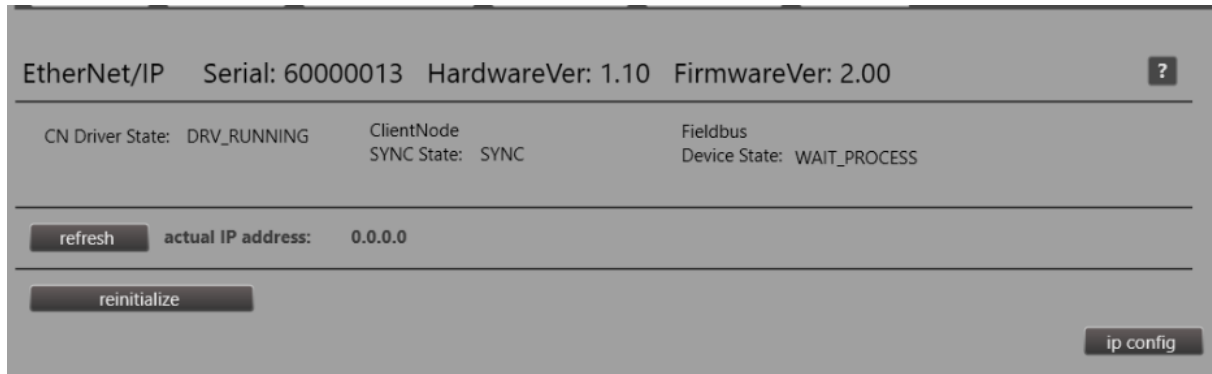

INSTRUCTION	
	<p>The device description file can only be used with the standard EtherNet/IP fieldbus configuration.</p>

5.6.8 Input commands

All fieldbus inputs can be defined via "alexConfigurator". In the data range and also data position. The suggested range of data listed in the table below gives the original data range of the command, but all commands can be stretched or compressed to any data range. The target module tells which module of the aflex control the command is directed to. Thus, e.g. the aflex controlled via the target module "aflex module". The control unit via the target module "control unit".

Table 15: Input commands

Target module	Designation:	Description	Native data range
Control Unit:	AutoMode:	<p>Optional Command</p> <p>Change-over option between automatic/manual mode.</p> <p>Manual mode (value 0): Parameters can only be changed using the "aflex Configurator".</p> <p>Automatic mode (value > 0): Parameters can only be changed via the field bus interface.</p> <p>If the configurator is connected, the field bus cannot be used to change over the operating mode.</p> <p>After disconnecting the TCP/IP connection to the "aflex Configurator", the ControlUnit changes to automatic mode. The ControlUnit also changes to automatic mode after each restart.</p> <p>If the command is linked in the field bus configuration, it must be set for to activate "automatic" mode. If not, then the ControlUnit will switch to "manual mode".</p>	1 Bit
Control Unit:	General Release	<p>General release without which all power outputs and the back light are deactivated. Must be set in order to use the aflex.</p> <p>This command can be used optionally for ControlUnit Firmware version v1.52 and higher. If the "General Release" is not linked in the field bus configuration, then the "General Release" is set automatically when changing to "automatic mode".</p>	1 Bit

		The command cannot be removed and must be actuated for the EtherCAT and Profinet interface.	
Control Unit:	Load Config Number	Load a saved configuration	8 Bit
Control Unit:	Load Config Number #1	Load a saved configuration (No. #1)	1 Bit
Control Unit:	Load Config Number #2	Load a saved configuration (No. #2)	1 Bit
Control Unit:	Load Config Number #3	Load a saved configuration (No. #3)	1 Bit
Control Unit:	Load Config Number #4	Load a saved configuration (No. #4)	1 Bit
Control Unit:	Load Config Number #5	Load a saved configuration (No. #5)	1 Bit
Control Unit:	Aux Power Output	Control of the 24V/4A PWM output on the control unit	16 Bit
aflex-Module	Intensity	Set the control intensity of aflex	32 Bit
aflex-Module	Frequency	Set the oscillation frequency of aflex Caution: minimum 16 bit necessary	32 Bit
aflex-Module	Direction	Set the direction of movement of aflex Not applicable for aflex 400 lv or aflex qc light products	32 Bit
Backlight Node	Light Intensity	Control of the backlight intensity of the Backlight Node	
T4X Driver	Channel1 Power	Separate control of individual driver outputs	32 Bit
T4X Driver	Channel2 Power	Separate control of individual driver outputs	32 Bit
T4X Driver	Channel3 Power	Separate control of individual driver outputs	32 Bit
T4X Driver	Channel4 Power	Separate control of individual driver outputs	32 Bit

T4X Driver	Channel1 Phase On	Separate setting of the phase shifts of individual driver outputs	32 Bit
T4X Driver	Channel2 Phase On	Separate setting of the phase shifts of individual driver outputs	32 Bit
T4X Driver	Channel3 Phase On	Separate setting of the phase shifts of individual driver outputs	32 Bit
T4X Driver	Channel4 Phase On	Separate setting of the phase shifts of individual driver outputs	32 Bit
T4X Driver	Channel1 Phase Off	Separate setting of the phase shifts of individual driver outputs	32 Bit
T4X Driver	Channel2 Phase Off	Separate setting of the phase shifts of individual driver outputs	32 Bit
T4X Driver	Channel3 Phase Off	Separate setting of the phase shifts of individual driver outputs	32 Bit
T4X Driver	Channel4 Phase Off	Separate setting of the phase shifts of individual driver outputs	32 Bit

5.6.9 Output commands

All fieldbus outputs can be freely defined via the "aflexConfigurator", both in the data range as well as in the data position. The suggested range of data listed in the table below indicates the original data range of the command. These are recommended for e.g. to stick with for 1-bit wide commands, however, all commands can be stretched or compressed to any data range. The target module tells from which module of the aflex control the status is generated.

Table 16: *Output commands*



Target module	Designation:	Description	Native data range
Control Unit:	AutoMode:	Status Automatic/Manual Mode.	1 Bit
Control Unit:	General Release	Status of release	1 Bit
Control Unit:	Load Config Number	Current loaded configuration	8 Bit
Control Unit:	Load Config Number #1	Status if configuration 1 is loaded	1 Bit
Control Unit:	Load Config Number #2	Status if configuration 2 is loaded	1 Bit
Control Unit:	Load Config Number #3	Status if configuration 3 is loaded	1 Bit
Control Unit:	Load Config Number #4	Status if configuration 4 is loaded	1 Bit
Control Unit:	Load Config Number #5	Status if configuration 5 is loaded	1 Bit
Control Unit:	Aux Power Output	Status of the control intensity on 24V output of the control unit	16 Bit
aflex-Module	Intensity	Status of the control intensity of aflex	32 Bit
aflex-Module	Frequency	Status of the oscillation frequency of aflex Caution: minimum 16 bit necessary	32 Bit
aflex-Module	Direction	Status of the direction of movement of aflex Not applicable for aflex 400 lv or aflex qc light products	32 Bit
Backlight Node	Light Intensity	Status of the backlight intensity of the Backlight Node	

T4X Driver	Channel1 Power	Status of the control intensity of driver output	32 Bit
T4X Driver	Channel2 Power	Status of the control intensity of driver output	32 Bit
T4X Driver	Channel3 Power	Status of the control intensity of driver output	32 Bit
T4X Driver	Channel4 Power	Status of the control intensity of driver output	32 Bit
T4X Driver	Channel1 Phase On	Status of the phase shifts of driver output	32 Bit
T4X Driver	Channel2 Phase On	Status of the phase shifts of driver output	32 Bit
T4X Driver	Channel3 Phase On	Display of the phase shifts of driver output	32 Bit
T4X Driver	Channel4 Phase On	Status of the phase shifts of driver output	32 Bit
T4X Driver	Channel1 Phase Off	Status of the phase shifts of driver output	32 Bit
T4X Driver	Channel2 Phase Off	Status of the phase shifts of driver output	32 Bit
T4X Driver	Channel3 Phase Off	Status of the phase shifts of driver output	32 Bit
T4X Driver	Channel4 Phase Off	Status of the phase shifts of driver output	32 Bit

6 Operating manual









The aflex is integrated in automated industrial systems and operated in the automatic mode via the communication interface. In addition, manual operation is possible via the configuration software.

6.1 Safety instructions for operation

 WARNING	
	<p>Danger of injury through electro-magnetic fields</p> <p>Persons who carry pacemakers or other active medial implants may be particularly vulnerable to EMF.</p> <p>Persons with active medical implants are not allowed to stay in the danger area</p>















6.2 LED Display

The LED status of the control modules must be monitored in case of error. The following is a list of possible messages

Picture	Legend
 /  / 	LED On
 /  / 	LED Off
 /  / 	LED Blinking
X	Without importance















Control Unit:

Table 17: LED-Displays Control Unit

con	err	pwr	Reporting
			Power supply IO, connected to control modules
			Power supply IO, no connection to further control modules
			Fault occurred during operation
			"Bootloader" mode is active
			"Bootloader" mode active, no executable program available

















T4X: Client Node

Table 18: LED-Displays Client Node

con	err	pwr	Reporting
			Power supply IO, connected to control modules
			Power supply IO, no connection to further control modules
			Fault occurred during operation
			"Bootloader" mode is active
			"Bootloader" mode active, no executable program available

PB Node:

Table 19: PB Node

con	err	pwr	pbcon	Reporting
				Power supply IO, connected to control modules
				Power supply IO, no connection to further control modules
			X	Fault occurred during operation
			X	"Bootloader" mode is active
			X	"Bootloader" mode active, no executable program available

EtherCAT Node:

Table 20: EtherCAT Node:

















con	err	pwr	fbdata	Reporting
				Power supply IO, connection to control modules established, FB data are exchanged
				Power supply IO, no connection to further control modules
			X	Fault occurred during operation
			X	"Bootloader" mode is active
			X	"Bootloader" mode active, no executable program available

Table 21: EtherCAT LED "nwstate"











LED	Reporting
 from	INIT – State (or no voltage)
 green stays on	OPERATIONAL State
 blinking green	PRE-OPERATIONAL State
 flashing green	SAVE-OPERATIONAL State
 flickering green	BOOT state
 red off	No existing error
 blinking red	Incorrect configuration
 red on	Internal errors

Table 22: EtherCAT LED "x2 con" / "x3 con"

LED	Reporting
 off	No recognized link
 stays on	Link recognized, no traffic
 blinking	Link recognized, traffic identified

Profinet Node:

Tabelle 23: Profinet Node

















con	err	pwr	fbdata	Reporting
				Power supply IO, connection to control modules established, FB data are exchanged
				Power supply IO, no connection to further control modules
			X	Fault occurred during operation
			X	"Bootloader" mode is active
			X	"Bootloader" mode active, no executable program available

Tabelle 24: Profinet LED „nwstate“













nwstate LED	description	comment
 off	Offline	No network connection
 green on	Online (Run)	Connection to IO Controller established. IO controller in RUN state
 green flash	Online (Stop)	Connection to IO Controller established. IO controller in Stop.
 green blink	Blink	Identification blink code. Activated from external tool for identification of the device.
 red on	Internal error	Unexpected internal error
 red, flashes once	error station name	No station name assigned
 red, flashes twice	error IP address	No ip address assigned
 red, flashes thrice	Error communication	Expected configuration differs to actual configuration

Tabelle 25: Profinet X2/X3

X2 / X3 LED	description	comment
 off	No link	X2/X3 not connected. No communication.
 on	Link	Ethernet connected, no traffic
 blink	Activity	Ethernet connected, traffic identified

7 Maintenance instructions

INSTRUCTION	
	<p>The aflex is maintenance-free.</p> <p>If repair or maintenance is still required, please contact the aflex manufacturer.</p>

8 Order address

Germany:

Afag GmbH
Wernher-von-Braun-Straße 1
D – 92224 Amberg
Tel.: ++49 (0) 96 21 / 65 0 27-0
Fax: ++49 (0) 96 21 / 65 0 27-490

Sales

sales@afag.com
www.afag.com

Switzerland:

Afag Automation AG
Luzernstrasse 32
CH – 6144 Zell
Tel.: ++41 (0) 62 / 959 86 86
Fax: ++41 (0) 62 / 959 87 87

9 Disposal

Devices which are no longer usable should be dismantled and recycled not as a whole unit, but in individual parts and according to type of materials. Non-recyclable components must be disposed of appropriately.

